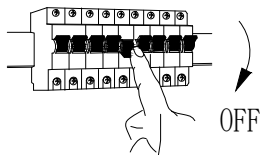
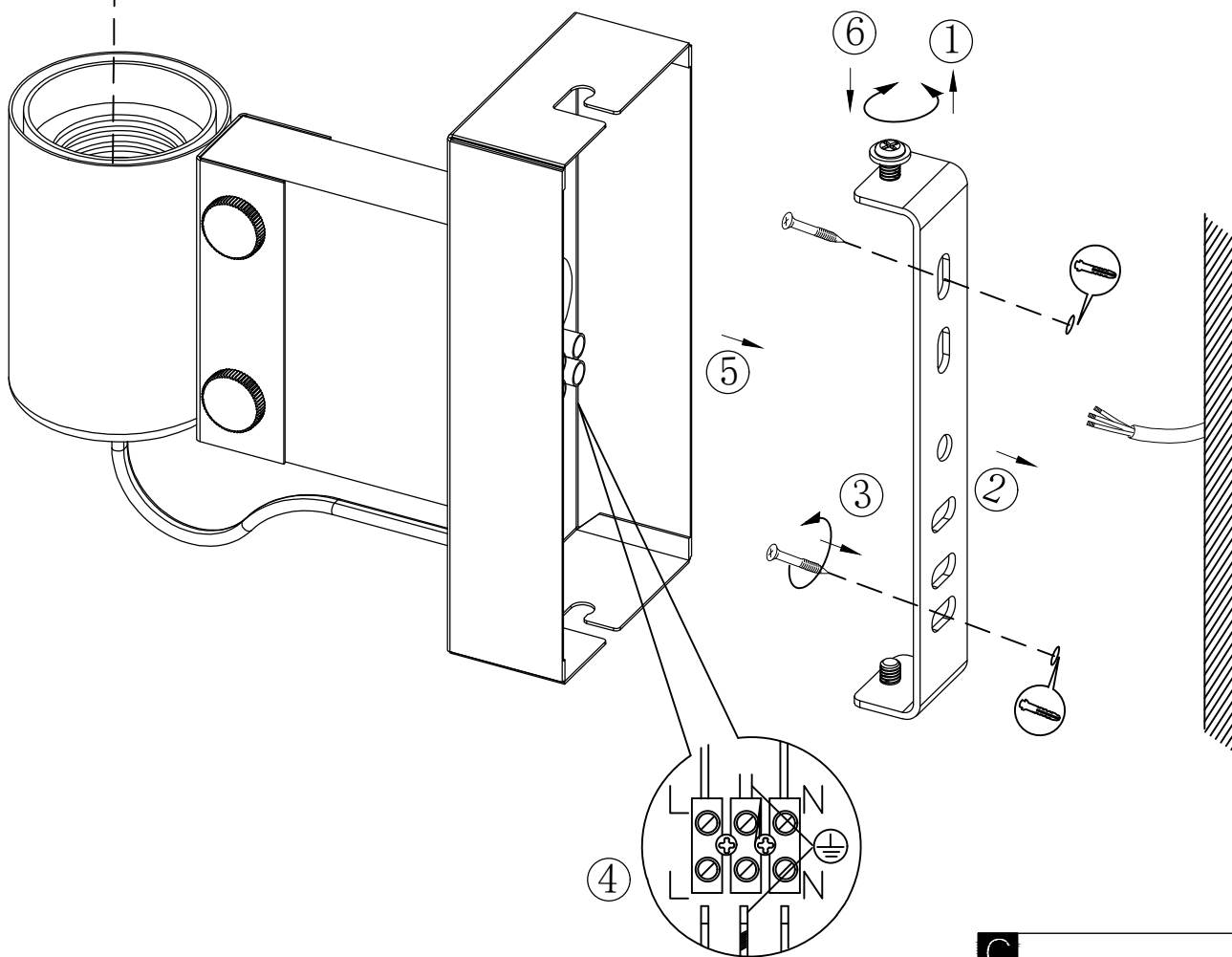
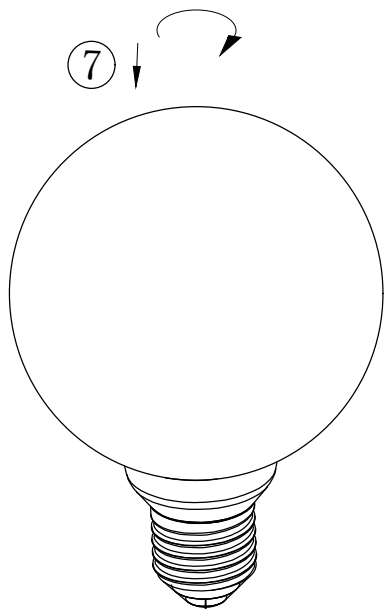
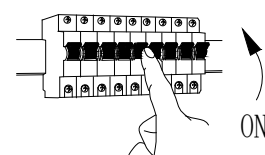

**A****B****C**

B43903  
www.eglo.com