

1	Overview.....	1
1.1	Diagram Drawing.....	1
1.2	Dimension.....	2
1.3	Functions.....	2
2	Communication.....	3
2.1	Shutter Global Object.....	3
2.2	Shutter Automatic Function Group Object.....	4
2.3	Shutter Channel Object.....	5
2.4	Online State Object.....	6
2.5	Universal Interface Channel Object.....	6
2.6	Universal Interface Logic Object.....	6
3	ETS Parameter.....	7
3.1	Channel Selection.....	7
3.1.1	Blinds.....	8
3.1.2	Shutter.....	8
3.2	Time for Movement.....	9
3.2.1	Measure of the times for movement.....	10
3.2.2	Movement time.....	11
3.2.3	Step time for blinds.....	11
3.2.4	Duration of blind adjustment.....	11
3.2.5	Pause at change of direction.....	11
3.2.6	Switch-on/Switch-off delay motor.....	12
3.2.7	Position of slats at end of driving.....	12
3.2.8	Short time operation.....	12
3.3	Object for absolute position/Statue objects.....	12
3.3.1	Driving to reference.....	13
3.3.2	Command for absolute positions.....	14
3.3.3	Status objects(actual position/direction).....	14
3.3.4	Report objects.....	14
3.4	Function object number 24/44/64.....	14
3.4.1	Limitation of driving area.....	15
3.4.2	Position start up via 1 bit object.....	16
3.5	Central objects.....	17
3.6	Scenes.....	18
3.6.1	Submenu scene.....	18
3.7	Automatic function.....	20
3.7.1	Subitem automatic function.....	21
3.7.2	Automatic blocks.....	22
3.8	Alert functions/superior functions.....	23
3.8.1	Order of alarms.....	24
3.8.2	Alarm types.....	24
3.8.3	Periodic observation.....	26

---

3.8.4	Normal blocking.....	26
3.8.5	Action at reset of alarms and blocks.....	26
3.8.6	Reaction when bus power down/up.....	27
3.9	Block functions.....	27
4	Input general.....	28
4.1	Input channel configuration.....	30
4.1.1	The input channel is configured with the same parameters.....	30
4.1.1.1	Blocking Object.....	30
4.2	Composite pattern parameter configuration.....	31
4.2.1	Dimming control.....	31
4.2.2	Shutter Control.....	32
4.2.3	Switch Control.....	33
4.3	Independent pattern parameter configuration.....	33
4.3.1	Switch.....	34
4.3.1.1	Switch falling edge/rising edge/both edge.....	34
4.3.1.2	Toggle rising/falling edge.....	35
4.3.1.3	Send Status.....	36
4.3.1.4	Send Value rising/falling/both edges.....	38
4.3.1.5	Send value with on/off delay.....	39
4.3.2	Scene.....	41
4.3.3	Counter.....	42
4.3.4	Switch short/long.....	44
4.3.5	One button Dimming.....	47
4.3.6	One button Shutter.....	48
4.4	LED output.....	48
4.5	Logic.....	49
4.5.1	Logic object type switch.....	51
4.5.2	Logic object type scene.....	52
4.5.3	Logic object type byte value.....	52
5	Contact.....	53



## Version

Version No.	Release Date	Description
V1.0	March 29 <sup>th</sup> , 2018	1 <sup>st</sup> Release

## Notice

1. Please read this user manual carefully before using the product.
2. This product is used in indoor environment and installed in electrical control box.
3. Please install this product in a dry and ventilated place.
4. Before power on, please confirm the input voltage according to the manual; after power on, please confirm the normal output voltage before connecting to the control bus.
5. Please make sure the secure shell is in good condition, if the shell is damaged, please stop using to avoid accident.
6. This product is NOT a toy, please make sure it is out of children touch.
7. Only be suitable for EIB/KNX system bus.
8. Others:  
The below sign indicates this product can't be dealt as ordinary family rubbish, in order to avoid the possible environment and human health harm caused by the electrical waste, this product must follow recovery processing. Please contact the local recycling department after this product is scrapped, to make sure it can go as the right waste processing procedure.



# 1 Overview

This equipment is used for the control of curtains or blinds, which can be fully opened, closed, percentage position adjustment and other functions. The opening of the curtain can be configured by parameters to achieve only movement in a particular area, to achieve scenario control, and to temporarily disable channels through blocking. The installation method of concealed installation can be directly placed in 86 boxes or 80 boxes, with 4-channel universal interface function, which can be used with ordinary panel.

## 1.1 Diagram Drawing

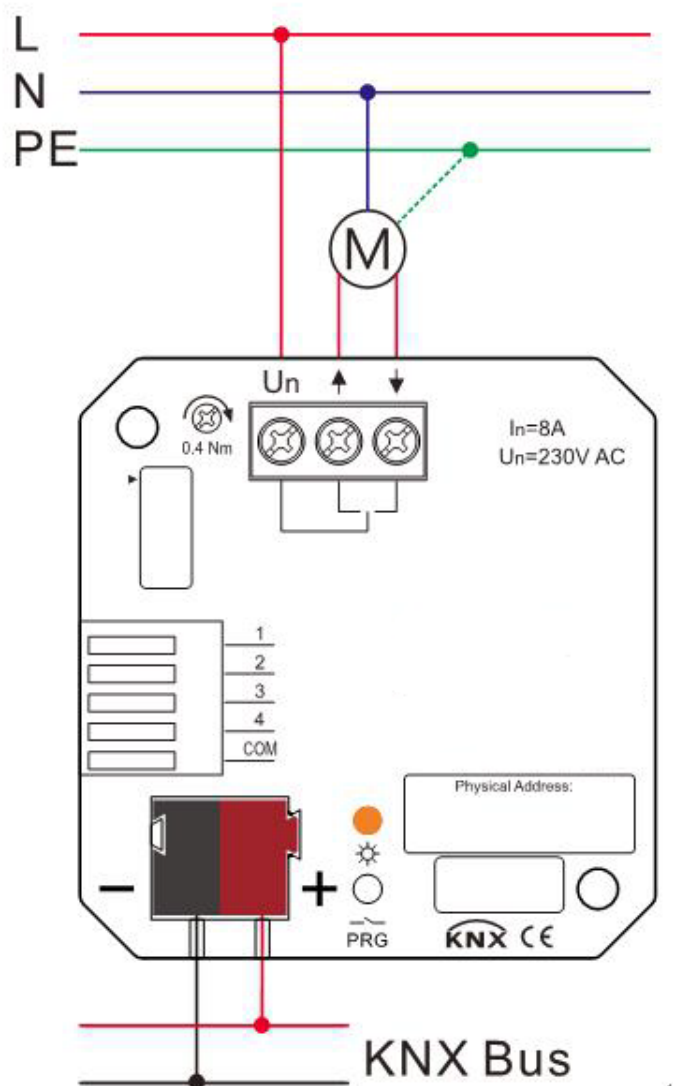

---

## 1.2 Dimension

Each device has 1-fold curtain function, the fold is equipped with two input key signal interface, the long press up/down button, manual control of the curtain movement, un-press of the button to stop. The two key input signals are fixed button function, which is used to control the curtain manually.

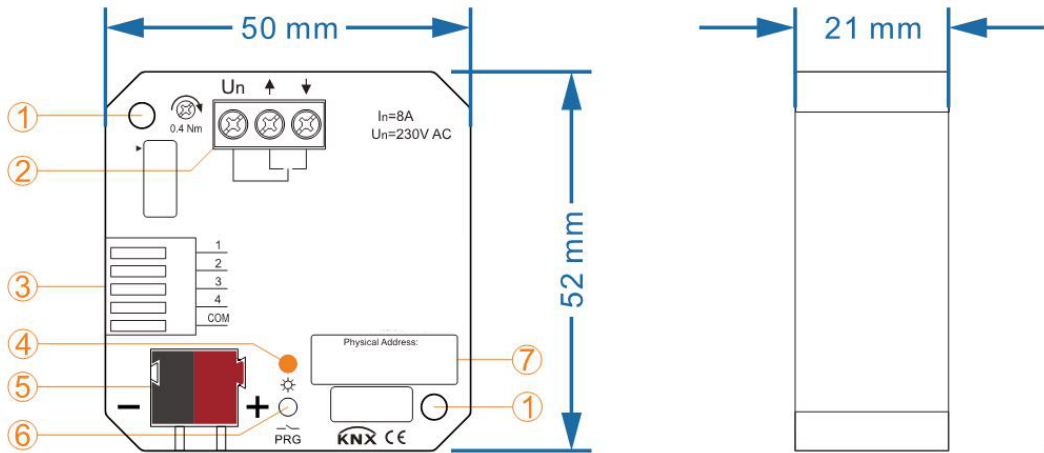

- 1) M3 screw fixed installation hole position \*2, suitable for non-concealed box type fixation.
- 2) output load terminal.
- 3) input signal terminals.
- 4) programming indicator (orange)
- 5) KNX bus terminal.
- 6) programming keys
- 7) address label box.

## 1.3 Functions

All channel functions are the same. Flexible configuration when used.

The following is the channel function selection:

Curtain pass function:

- not active

The channel is forbidden and the parameters cannot be configured.

- shutter

Choose this function, can make all sorts of configuration to the curtain move, this can control all sorts of curtain motor easily. It Can also set in the curtain direction change when pause for a period of time, and set up/off delay to adjust the inertia of the motor. You can receive positioning commands and direct control of the curtain to the specified percentage position.

- blinds

---

Choose this function, can make all sorts of configuration to the curtain move, this can control all sorts of curtain motor easily. It Can also set in the curtain direction change when pause for a period of time, and set up/off delay to adjust the inertia of the motor. You can receive positioning commands and direct control of the curtain to the specified percentage position.

Universal interface channel function:

The following functions are applicable to all universal interface channels. Additionally, 2 logical functions are supported.

The corresponding functions of each channel are as follows:

- **disabled:** current channel is with no function, do not make any response
- **enabled:** current channel can make the related functions
- **channels grouped:** two adjacent channels are used together as a group
- **channels unique:** two adjacent channels are used independently

## 2 Communication

The configuration project needs to use a communication object to configure a different group address for the communication object to achieve the associated operation.

The first five communication objects are global objects, meaning that these objects can control multiple channels. Then there are eight group objects assigned to the automatic control function, objects 5 to 8 belong to the automatic control block A, objects 9 to object 12 belong to the automatic control block B.

Starting with the 13th object, each channel assigns a fixed group object. There are 19 objects in each channel. Object display is related to parameter configuration, and channel A is from 13 to 32. Note: Concealed 1-fold curtain actuator only has channel A.

### 2.1 Shutter Global Object

A single channel can choose whether or not to respond to a global object's operation through a parameter configuration. The display of the global object is independent of the channel activation, and the global object will be displayed even if all channels are not activated.

The first three of the five global objects in the curtain actuator are a 1-bit communication object that controls the movement of the curtain up and down. The remaining two objects have a size of 1 byte and can control the movement of the curtains by percentage.

Nu...	Name	Object Function	Description	Group Addresses	Leng...	C	R	W	T	U	Data Type	Priority
0	all Channels	Shutter up/down			1 bit	C	-	W	-	-	1 bit DPT_Up...	Low
1	all Channels	Blinds up/down /Stop			1 bit	C	-	W	-	-	1 bit DPT_Op...	Low
2	all Channels	Stop			1 bit	C	-	W	-	-	1 bit DPT_Swi...	Low
3	all Channels	Absolute position			1 Byte	C	-	W	-	-	8 bit unsigne...	Low
4	all Channels	Absolute position of blinds			1 Byte	C	-	W	-	-	8 bit unsigne...	Low

NO.	Function	Instruction	Data Type
0	Shutter up/down	Switch command, control the shutter up/down movement	DPT 1.008
1	Blinds up/down/Stop	Control blinds move/stop	DPT 1.007
2	Stop	Stop moving	DPT 1.007
3	Absolute position	Move to absolute position	DPT 5.001
4	Absolute position of blinds		DPT 5.001

## 2.2 Shutter Automatic Function Group Object

For two automatic function blocks A and B, the four objects of each functional block usually have different location parameters. That is, the parameter values for each object range from 0% to 100%. The size of the object itself is 1 bit.

Nu...	Name	Object Function	Description	Group Addresses	Leng...	C	R	W	T	U	Data Type	Priority
5	Automatic A	Automatic position 1			1 bit	C	-	W	-	-	1 bit DPT_Swi...	Low
6	Automatic A	Automatic position 2			1 bit	C	-	W	-	-	1 bit DPT_Swi...	Low
7	Automatic A	Automatic position 3			1 bit	C	-	W	-	-	1 bit DPT_Swi...	Low
8	Automatic A	Automatic position 4			1 bit	C	-	W	-	-	1 bit DPT_Swi...	Low
9	Automatic B	Automatic position 1			1 bit	C	-	W	-	-	1 bit DPT_Swi...	Low
10	Automatic B	Automatic position 2			1 bit	C	-	W	-	-	1 bit DPT_Swi...	Low
11	Automatic B	Automatic position 3			1 bit	C	-	W	-	-	1 bit DPT_Swi...	Low
12	Automatic B	Automatic position 4			1 bit	C	-	W	-	-	1 bit DPT_Swi...	Low

NO.	Function	Instruction	Data Type
5	Automatic A	Receive command, automatically locate position.	DPT 1.017
6	Automatic A	Receive command, automatically locate position.	DPT 1.017
7	Automatic A	Receive command, automatically locate position.	DPT 1.017
8	Automatic A	Receive command, automatically locate position.	DPT 1.017
9	Automatic B	Receive command, automatically locate position.	DPT 1.017
10	Automatic B	Receive command, automatically locate position.	DPT 1.017
11	Automatic B	Receive command, automatically locate position.	DPT 1.017
12	Automatic B	Receive command, automatically locate position.	DPT 1.017

## 2.3 Shutter Channel Object

Each channel has 19 object configurations that occupy an object location regardless of whether the object is used. Channel A is numbered 13-32, channel B is 33-52, channel C is 53-72, and channel D is 73-92.

Nu...	Name	Object Function	Description	Group Addresses	Leng...	C	R	W	T	U	Data Type	Priority
13	Channel A	Shutter up/down			1 bit	C	-	W	-	-	1 bit DPT_UpD...	Low
14	Channel A	Blinds up/down /Stop			1 bit	C	-	W	-	-	1 bit DPT_Ope...	Low
16	Channel A	Scene			1 Byte	C	-	W	-	-		Low
17	Channel A	Act. direction			1 bit	C	R	-	T	-	1 bit DPT_UpD...	Low
18	Channel A	Absolute position			1 Byte	C	-	W	-	-	8 bit unsigned ...	Low
19	Channel A	Absolute position of blinds			1 Byte	C	-	W	-	-	8 bit unsigned ...	Low
20	Channel A	Actual position			1 Byte	C	R	-	T	-	8 bit unsigned ...	Low
21	Channel A	Actual position of blinds			1 Byte	C	R	-	T	-	8 bit unsigned ...	Low
22	Channel A	Act. position valid			1 bit	C	R	-	T	-	1 bit DPT_Bool	Low
23	Channel A	Start driving to reference			1 bit	C	-	W	-	-	1 bit DPT_Switch	Low
24	Channel A	Drive to limitation			1 bit	C	-	W	-	-	1 bit DPT_Switch	Low
25	Channel A	State upper Position			1 bit	C	R	-	T	-		Low
26	Channel A	State lower Position			1 bit	C	R	-	T	-		Low
27	Channel A	Block absolute position mode			1 bit	C	-	W	-	-	1 bit DPT_Enable	Low
28	Channel A	Block universal mode			1 bit	C	-	W	-	-	1 bit DPT_Enable	Low
32	Channel A	Block			1 bit	C	-	W	-	-	1 bit DPT_Enable	Low

### Channel Object Description

NO.	Function	Instruction	Data Type
13	Shutter up/down	Up/down move	DPT 1.007
14	Blinds Up/Down/Stop	Move/stop	DPT 1.007
14	Short time operation	Short time operation	DPT 1.007
15	Stop	Stop moving	DPT 1.017
16	Scene	Scene calls	DPT 18.001
17	Status actual Direction	Move direction	DPT 1.008
17	Status of movement	Move status	DPT 1.008
18	Absolute position	Move to absolute position	DPT 5.001
19	Absolute position of blinds	Blinds move to absolute position	DPT 5.001
20	Status actual position	Actual position	DPT 5.001
21	Status actual position of blinds	Blinds actual position	DPT 5.001
22	Act. Position valid	Indicate actual position valid or not	DPT 1.002
23	Start driving to reference	Start driving	DPT 1.008
24	Drive to limitation	Drive to limitation	DPT 1.008
24	Drive to position	Drive to position	DPT 1.008
25	State upper position	State upper position	DPT 1.001
26	State lower position	State lower position	DPT 1.001
27	Block absolute position mode	Block absolute position mode	DPT 1.003
28	Block universal mode	Block universal mode	DPT 1.003
29	Wind alarm	Wind alarm	DPT 1.005
30	Rain alarm	Rain alarm	DPT 1.005
31	Frost alarm	Frost alarm	DPT 1.005
32	Block	Channel block	DPT 1.003



## 2.4 Online State Object

The online state object indicates that the device is running normally on the bus and sending state actively.

NO.	Function	Instruction	Data Type	
33	Online	sending state actively	No	output, read

## 2.5 Universal Interface Channel Object

Each channel has its corresponding five object numbers, which in turn are channel A:34-38;Channel B: 39-43;Channel C: 44-48;Channel D: 59-63;

The object location will be occupied permanently and will not change due to schema changes.

The corresponding object of a channel.

NO.	Function	Use	Data Type	Read-write
34	Switch	Edge control	DPT 1.001	Read
34	Send forced setting	forced setting	DPT 2.001	Read
34	Shutters down/up	Shutter control	DPT 1.008	Read
34	Dimming on/off	Flip the dimming	DPT 1.001	Read
34	Switch on/off	Double control switch	DPT 1.001	Read
34	Reset counter	Reset counter	DPT 1.001	Write
34	Send value	Send value	DPT 5.001	Read
34	Push button short	Push button short	DPT 1.001	Read
35	Value for toggle	Edge control flip value	DPT 1.001	Write
35	Stop/Blinds open/close	Shutter drive/blinds stop	DPT 1.009	Read
35	Dimming	Dimming	DPT 3.007	Read
36	Scene	Scene	DPT 18.001	Read
36	Value for change of direction	Shutter movement direction	DPT 1.001	Read
36	Push button long	Push button long	DPT 1.001	Read
37	Counter	Counter	DPT 12.001	Read
38	Blocking object	Blocking object	DPT 1.001	Write
<b>+5</b>	<b>Next channel</b>			
76	LED output A	LED control	DPT 1.001	Read

## 2.6 Universal Interface Logic Object

Each device has two logical functions, each logical function is equipped with two logical input

object, a logic output object, and you can choose any channel to participate in the logical operation, end object Numbers from 64 to 64.

### Channel A Logic Object

	Numl	Name	Object Function	Description	Group Address	Length	C	R	W	T	U	Data Type	Priority
64		Logic	Input 1 A			1 bit	C	-	W	T	U	boolean	低
65		Logic	Input 1 B			1 bit	C	-	W	T	U	boolean	低
66		Logic	Output 1			1 bit	C	R	-	T	-	switch	低
67		Logic	Input 2 A			1 bit	C	-	W	T	U	boolean	低
68		Logic	Input 2 B			1 bit	C	-	W	T	U	boolean	低
69		Logic	Output 2			1 bit	C	R	-	T	-	switch	低

### Logic Object Description

NO.	Function	Use	Data Type	Read-Write
64	Logic input 1A	Logic 1input A	DPT 1.001	Write
65	Logic input 1B	Logic 1input B	DPT 1.001	write
66	Logic output 1	logic1 output	DPT 1.001	read
66	Logic output 1 Scene	Logic 1output scene	DPT 18.001	read
66	Logic output 1 Value	Logic 1 output value	DPT 5.010	read
67	Logic input 2A	Logic 2 input A	DPT 1.001	write
68	Logic input 2B	Logic 2 input B	DPT 1.001	write
69	Logic output 2	Logic 2 output	DPT 1.001	read
69	Logic output 2 Scene	Logic 2output scene	DPT 18.001	read
69	Logic output 2 Value	Logic 2 output value	DPT 5.010	read

## 3 ETS Parameter

Each time a device is downloaded or rebooted, a location operation must be performed (up to the top, down to the bottom), and the goal is to bring the curtain back to a manageable position.

### 3.1 Channel Selection

Channel activated menu

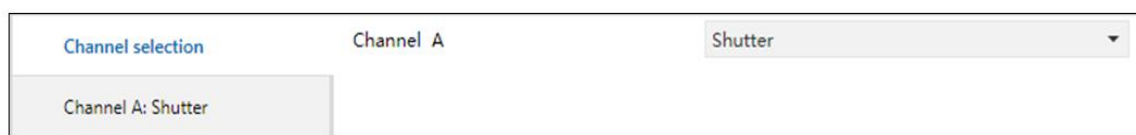

Name	Range [default]	Remark
Channel A	<ul style="list-style-type: none"> <li>● not active</li> <li>● Shutter</li> <li>● Blinds</li> </ul>	Channel working mode

The channel can choose to work in "shutter", "blinds", "not active" three modes. The difference between "shutter" and "blinds" is that the latter can control the movement of the strip and have the step function.

### 3.1.1 Blinds

If a channel is selected as "blinds" mode, the channel can be configured with many parameters and two objects will appear:

NO.	Name	Length	Use
13	Shutter up/down	1 bit	Shutter move
14	Blinds up/down/stop	1 bit	Blinds move/or shutter stop

The communication object "Shutter up/down" is used for curtain movement, and the 0 value represents the upper shift, and the 1 value represents the lower shift.

The communication object "Blinds up/down/stop" is used for stepping control, or moving to stop.

### 3.1.2 Shutter

If a channel is selected as the "Shutter" mode, the channel can be configured with many parameters and three objects will appear:

NO.	Name	Length	Use
13	Shutter up/down	1 bit	Shutter move
14	Short time operation	1 bit	Move in short time
15	Stop	1 bit	Shutter stop

The communication object "Shutter up/down" is used for shutter movement control.

The communication object "Short time operation" is used to control the shutter to move in a short time, which can achieve a relatively accurate small range movement.

The communication object "Stop" is used to Stop the shutter.

---

## 3.2 Time for Movement

Each channel has some timing parameters to control the shutter movement time. In order to ensure that the shutter can be fully opened/closed, the time parameters required for the parameters must be determined according to the actual shutter running time.

Channel B: Shutter	
Time for movement for Up/Down (sec)	same
Time for movement (sec)	10
Extension of time for movement	10%
Step time for blinds (ms)	1000
Duration of blinds adjustment (ms)	5000
Pause at change of direction (ms)	1000
Switch-on delay motor (ms)	0
Switch-off delay motor (ms)	0
Position of blinds at end of driving	100%

Channel B: Blinds	
Time for movement for Up/Down (sec)	same
Time for movement (sec)	10
Extension of time for movement	20%
Short time operation	not activ
Pause at change of direction (ms)	100
Switch-on delay motor (ms)	0
Switch-off delay motor (ms)	0

Name	Range [Default]	Remark
Time for movement up/down	<ul style="list-style-type: none"> <li>● Same</li> <li>● different</li> </ul>	Select the time setting type, and select different when the up/down moving time can be set separately.
Time for movement Time for movement up/down	1-10000s [45s]	Set the movement duration
Extension of time for movement	No extension,2%,5%,10%, 15%,20%	Extend the movement time to compensate for the movement error, and ensure that the curtain can be completely closed/opened. Do not participate in the calculation of absolute position.
Step time for slats	50-1000ms [200ms]	Blinds only works. Set sheet bar to walk in time.
Duration of slat adjustment	10-10000ms [1200ms]	Blinds only works. Set the total step time.
Pause at change of direction	1-1000ms [500ms]	Set the gap time when the direction changes. Prevent inertia of the motor.
Switch-on delay motor	0-255ms [0ms]	Some motors have low power and need a start buffer time.
Switch-off delay motor	0-255ms [0ms]	Some of the motors received a delay in receiving the turn off signal.
Position of blinds at end of driving	0-100% [50%]	Blinds only works. Set the board position.
Short time operation	<ul style="list-style-type: none"> <li>● not active</li> <li>● active</li> </ul>	Shutter mode only works. Activate the short-time travel function.
Time for movement for short time operation	50-1000ms [200ms]	Shutter mode only works. Set the duration of each short run of the motor.

### 3.2.1 Measure of the times for movement

The moving time of the curtain must refer to the manufacturer's parameters, or do the test to get the actual opened/closed time.

For more precise control, should set up a time to make the curtain in open/closed state, and then

---

adjust several small time , ensure the curtain just can open/close.

### **3.2.2 Movement time**

The movement of the curtain is based on time, and when the time is on, the curtain will be stopped, whether the curtain reaches the end point or not.

If the curtains open and close require different times, they should be configured separately. The extended time can be used to ensure that the curtains are fully opened/closed. After all, the operation of the motor is in error, and this error is offset by adding an extended time.

### **3.2.3 Step time for blinds**

It can control the sunlight penetration Angle through the strip operation. Adjust the Angle at any time according to the daylight hours to ensure the light transmittance and light transmittance.

Defining the single step length and total time can determine how many steps are required from 0% to 100%.

Example:

The total step time is 4000ms.

The single step time is 200ms.

Step number =  $4000/200 = 20$ .

### **3.2.4 Duration of blind adjustment**

The total control time of the blind also needs to be set according to the actual test results, which is the adjustment of the total control time from 0% to 100%.

The shorter the setup time, the smaller the Angle adjustment.

### **3.2.5 Pause at change of direction**

The parameter "pause at change of direction" is used to protect the motor when the curtain is running. Because the motor stops will continue to roll for a while because of its inertia, in order to prevent instantaneous change direction to cause the motor damaged, must wait for a while when the motor stop to make sure the motor reversal when it is fully stopped. Considering that the parameters of different motors may be different, it is necessary to set the time according to the actual parameters of the motor.

---

### 3.2.6 Switch-on/Switch-off delay motor

Some motors cannot run fully when they are on power, so set the parameter "Switch-on delay" to wait for full power operation of the motor.

In addition, some motors will continue to operate for a while after the power is off, so the parameter "Switch-off delay" is set to wait for the motor to stop.

### 3.2.7 Position of slats at end of driving

This parameter is valid only in the "blinds" mode.

The "Position of slats at end of driving" can be set to the Angle after the curtain has been removed. The operation relies on the object "Shutter up/down" to execute, and then control the strip opening Angle after the curtain is moved. The minimum percentage of slats is set to 1%, ranging from 0% to 100%. 0% of them are fully open and 100% is completely closed.

If the curtain move process receives the stop command, then the subsequent operation will stop.

### 3.2.8 Short time operation

This parameter is valid only in the "shutter" mode.

Short - term operation makes the curtain move can be operated according to micro-step, convenient and accurate control curtain position.

## 3.3 Object for absolute position/Statue objects

The curtain can be moved to a designated location by the location object.

Objects for absolute position	activ
Reaction after driving to reference	no reaction
Status objects	activ
Status object for visualization	Status actual direction

Name	Range Default]	Remark
Object for absolute position	<ul style="list-style-type: none"><li>● not active</li><li>● active</li></ul>	Activates the location object function.

Reaction after driving to reference	<ul style="list-style-type: none"> <li>● <b>no reaction</b></li> <li>● drive to former position</li> </ul>	This parameter is displayed when the object function is active. Move the curtains to the specified location after the calibration is performed.
Status objects	<ul style="list-style-type: none"> <li>● <b>not active</b></li> <li>● active</li> </ul>	Active state object.
Status object for visualization	<ul style="list-style-type: none"> <li>● <b>Status actual direction</b></li> <li>● Status of movement</li> </ul>	Specify status display content: Indicates movement direction. Indicates whether to move

NO.	Name	Length	Use
17	Status actual direction	1 bit	Indicates the actual direction of the curtain movement.
17	Status of movement	1 bit	Indicates whether the curtain is moving.
18	Absolute position	1 byte	Controls the curtain to move to the specified position
19	Absolute position of slats	1 byte	The control slats opens to the specified Angle.
20	Status actual position	1 byte	Indicate the actual position of the curtain
21	Status act. Position of slats	1 byte	Indicates the actual Angle of the slats
22	Act. Position valid	1 bit	Indicates whether the calibration operation is performed or not, if not, the curtain location is not performed.
23	Start driving to reference	1 bit	Start the calibration operation
25	State upper position	1 bit	Instruct the curtain to open completely
26	State lower position	1 bit	Instruct the curtain to close completely

### 3.3.1 Driving to reference

The curtain actuator must perform a position calibration operation after the power is on, because the curtain position may be moved after the curtain actuator has lost power. Only after performing the calibration operation, the actuator can work normally.

A calibration operation is actually a complete open/close operation of the actuator. The operation is performed automatically once every time it is charged, and it can be executed by issuing a command to the calibration object during normal work.

The calibration operation should be carried out regularly to ensure the correctness of the curtain position. Depending on the actual situation, you can modify the execution interval, usually once a week.

Because the movement of the curtain is based on the time of operation, actuators cannot receive motor position feedback, therefore, after multiple executions the error of curtain movement position may occur, especially operate un-full open/close frequently. In either case, perform calibration operation regularly is necessary.

The parameter "driving to former position" can control the curtain to move to a specified location



---

after performing the calibration . This parameter must be activated to be valid.

In fact, the calibration does not have to be executed by command, and manual operation can also be replaced. For example, press the manual button on the device to make the curtain perform a full open/closed operation, and then the curtain calibration is completed.

### **3.3.2 Command for absolute positions**

The curtain can be moved to an absolute location by 1 byte of location object. Location range 0-100%, resolution 1%.

The object "Absolute position" is used to set the actual position of the curtain. In addition, there is an object "absolute position of slats" that is used to set the position of the slats, but the object is only valid in the "blinds" mode.

For the percentage setting of the curtain, 0% indicates complete opening and 100% indicates complete closed.

### **3.3.3 Status objects(actual position/direction)**

Object "Status actual position" indicates the actual location of the curtain. Object "Status act. Position of slats" indicates that the slats opens Angle.

The object "Status current direction" and "Status of movement" are used to indicate the direction of the curtain and whether it is moving. The two objects share an object number, so only one of them can be activated. When the "Status current direction" is selected, 1 represents the move up and 0 represents the move down. When selecting the "Status of movement", 1 indicates that it is moving and 0 indicates no movement.

### **3.3.4 Report objects**

The object "state lower position" and "state upper position" are all 1 bit size, respectively, to indicate whether the curtain is completely closed or open.

A 0 signal will be sent when the object leaves 0 or 100%, and a 1 signal will be sent.

## **3.4 Function object number 24/44/64...**

Parameter "Function object number 24/44..."Used to activate the area limit function. Each channel has one object, channel A is 24, channel B is 44, and so on.

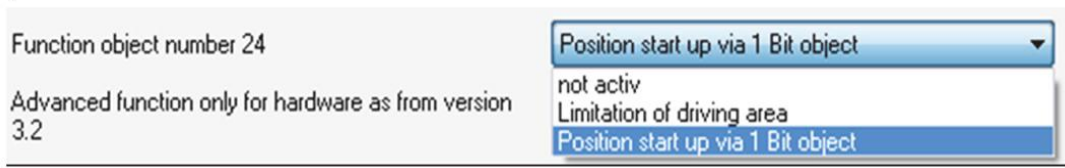

### Functional object selection

Name	Range [Default]	Remark
Function object number 24	<ul style="list-style-type: none"> <li>● Not active</li> <li>● Limitation of driving area</li> <li>● Position start up via 1 bit object</li> </ul>	Activate the function object, select the function

### Functional object

NO.	Name	Length	USE
24	Drive to limitation	1 bit	Control the curtain to move to upper/lower limit area.
24	Drive to position	1 bit	Control the curtain to move to the setting position

## 3.4.1 Limitation of driving area

This parameter is used to set the restricted area.

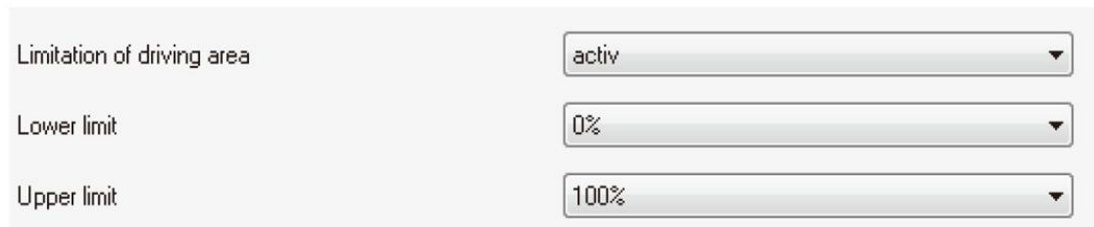

### Area Limitation parameter

Name	Range [Default]	Remark
Limitation of driving area	<ul style="list-style-type: none"> <li>● not active</li> <li>● active</li> </ul>	Activate the area limit function.
Lower limit	0-100% [0%]	Select the minimum moving value.
Upper limit	0-100% [100%]	Select the maximum moving value.

After activating the area limitation function, the following objects will be displayed:

NO.	Name	Length	Use
24	Drive to limitation	1 bit	Control the curtain to move to maximum/minimum position

The object "Drive to limitation" can control the curtain to move to the maximum position "Upper limit" and the minimum position "Lower limit". The signal 1 indicates the maximum position to move, and the signal 0 indicates the minimum position to move.

Area limit parameters affect the position feedback object, such as: set the minimum position was 30%, the maximum position was 80%, through object "Drive to limitation" to move to 80%, the maximum object "State upper position" will send 1, move to the bottom 30%, the object "State lower position" 1 will be sent.

In the process of controlling the curtain movement through the area restriction object, if the stop command is received, the movement will stop normally.

The area limit parameter does not affect the normal moving object "shutter up/down". When the curtain is controlled by the object, it can still move from 0% to 100%.

### 3.4.2 Position start up via 1 bit object

If the function of the functional object is set to "Position start up via 1bit object", a new parameter configuration will appear.

#### Function parameters

Name	Range [Default]	Remark
Function object number 24	Position start up via 1Bit object	Select function
Action at value = 1	<ul style="list-style-type: none"> <li>● <b>Drive to position</b></li> <li>● Drive to position if blind/shutter is up</li> <li>● Drive to position if blind/shutter is down</li> </ul>	The function object performs the configuration when it receives signal 1.
Position of blinds/shutter/slats	0-100% [50%]	Set the moving position of the curtain/slat corresponding to the

		function object.
Action at value = 0	<ul style="list-style-type: none"> <li>● no function</li> <li>● move up</li> <li>● move down</li> </ul>	Select the operation when the function object receives signal 0

Moving from one object to an absolute location, this feature only affects the corresponding individual channel compared to the automatic functionality.

The object values 1 and 0 can be set differently, with the parameters "Action at value 1" and "Action at value 0" respectively.

Corresponding operation parameters "Action at the value 0" only under the condition of limited, that means when the zero signal is received, the curtain is not moved by other objects command, otherwise the corresponding operation will not be executed.

### 3.5 Central objects

Each channel can select whether to respond to the operation of the total control object or not.



#### General Control Selection

Name	Range [Default]	Remark
Central objects	<ul style="list-style-type: none"> <li>● <b>not active</b></li> <li>● active</li> </ul>	Activate/disable the total control function of the channel

#### General control object

NO.	Name	Length	Use
0	Shutter up/down	1 bit	Controls all channel movements
1	Blinds up/down/stop	1 bit	"Blinds" mode step in, "shutter" mode stop
2	Stop	1 bit	stop
3	Absolute position	1 byte	Controls all channels to the specified location
4	Absolute position of blinds	1 byte	Control all channel slat angles.

Object 0 "shutter up/down" is used to control all channels that activate the total control function, regardless of the mode of the channel.

Object 1 "blinds up/down/stop" is only used to control the channel step and stop of the "blinds" mode.

Object 2 "stop" is the global stop function, which is used to stop the curtain movement. Both

---

modes are applicable.

Object 3 "absolute position" is used to control the curtain to move to absolute position. Both modes are applicable.

Object 4 "absolute position of slats" is used to control the channel in "blinds" mode, and give the slat an absolute Angle.

## 3.6 Scenes

The simplest way to achieve multiple functions, such as lighting, air conditioning, and curtains, is to use the scene function. Normally, in order to turn on the lights, the air conditioner is cooled, and the curtains are opened and that requires at least three commands to achieve the goal, which is to press at least three different buttons. It can be tedious to do so. Then, the benefits of the scene are shown, and a single keystroke can be used to automatically move the devices to a certain state.

Each channel of the device type for each executor can be configured with up to eight scenarios. Once the scene function of the activation channel is enabled, the channel can respond to the scenario command.

Scenarios can also configure learning capabilities. When the learning function of the activation channel is enabled, the channel will save the current value and replace it when the learning command is received through the scene object.

Previously configured values, this allows you to modify the scene function of the channel flexibly.

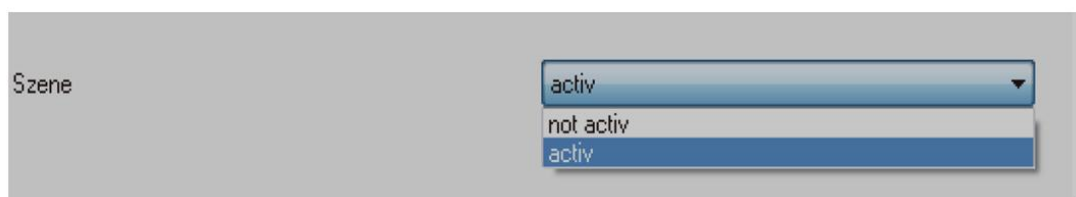

### Scene objects

NO.	Name	Length	Use
16	Scene	1 byte	Scene call object

Scenario number to call is through the scene, the scene for the range of 1-64, but the corresponding value of 0-63 to the actual scene, that is, when the number set the scene for 1, send the value of the actual object is zero, the scene number to 64, the value of the object is actually 63. This transformation is automatically converted by the device's internal program, which is only required to select one from the 1-64 number as a scenario number through the ETS configuration.

### 3.6.1 Submenu scene

A channel can be configured with 8 scenarios, which is a channel with up to 8 scenarios, which is sufficient for general applications.

The following figure shows a screenshot of the scenario.

Save scenes  not active  active

Scene Number A	not active
Scene A - position	0%
Scene A - position of slats	0%
Scene Number B	not active
Scene B - position	0%
Scene B - position of slats	0%
Scene Number C	not active
Scene C - position	0%
Scene C - position of slats	0%
Scene Number D	not active
Scene D - position	0%
Scene D - position of slats	0%

#### Parameters

Name	Range [Default]	Remark
Save scene	not active active	Activate the learning function. If the function is not activated, the learning command received will be ignored.
Scene A position	0-100% [0%]	Configure the absolute position of the curtain movement.
Scene A position of slats	0-100% [0%]	The "blinds" mode is valid only when the slat is moved.
Scene number A	1-64 [1]	The scenario number is used to determine which of the eight scenarios is invoked.

The execution of the scenario is also affected by the channel parameters, and the execution of the scenario is the same as the absolute location, subject to the same parameter constraints.

A channel can configure up to eight scenario patterns, so it is possible to distinguish between the current invocation and the scenario pattern by the scenario number. The number of different scenario pattern configurations for the same channel should be unique.

The call function and learning function of the scene use the same scene object, but the value is different, as shown in the following table:

Scene NO.	Call		Learning	
	hexadecimal	decimal	hexadecimal	decimal
1	0x00	0	0x80	128
2	0x01	1	0x81	129
3	0x02	2	0x82	130
4	0x03	3	0x83	131
5	0x04	4	0x84	132
6	0x05	5	0x85	133
7	0x06	6	0x86	134
8	0x07	7	0x87	135
9	0x08	8	0x88	136
10	0x09	9	0x89	137
11	0x0A	10	0x8A	138
12	0x0B	11	0x8B	139
13	0x0C	12	0x8C	140
14	0x0D	13	0x8D	141
15	0x0E	14	0x8E	142
16	0x0F	15	0x8F	143
17	0x10	16	0x90	144
18	0x11	17	0x91	145
19	0x12	18	0x92	146
20	0x13	19	0x93	147
21	0x14	20	0x94	148
22	0x15	21	0x95	149
23	0x16	22	0x96	150
24	0x17	23	0x97	151
25	0x18	24	0x98	152
26	0x19	25	0x99	153
27	0x1A	26	0x9A	154
28	0x1B	27	0x9B	155
29	0x1C	28	0x9C	156
30	0x1D	29	0x9D	157
31	0x1E	30	0x9E	158
32	0x1F	31	0x9F	159

### 3.7 Automatic function

Each channel can activate the automatic function and can configure up to 4 invocation conditions. The automatic feature can be chosen to belong to "block A" or "block B", which means that the automatic function can implement the operation mode similar to the scenario call.

Automatic function

### 3.7.1 Subitem automatic function

After each channel activates the automatic function, more configurable parameters appear.

**Channel A: Automatic**

Automatic objects	<input type="text" value="Block A"/>
Automatic function 1 - Position	<input type="text" value="100%"/>
Automatic function 1 -position of blinds	<input type="text" value="100%"/>
Automatic function 2 - Position	<input type="text" value="50%"/>
Automatic function 2 -position of blinds	<input type="text" value="25%"/>
Automatic function 3 - Position	<input type="text" value="75%"/>
Automatic function 3 -position of blinds	<input type="text" value="0%"/>
Automatic function 4 - Position	<input type="text" value="30%"/>
Automatic function 4 -position of blinds	<input type="text" value="50%"/>

Each channel has four different automatic functions. The related parameter configuration is similar.

Name	Range [Default]	Remark
Automatic objects	<ul style="list-style-type: none"> <li>● Block A</li> <li>● Block B</li> </ul>	Sets the automatic function of the channel to which block object.
Automatic function1-(4) Position	0-100% [0%]	Set the absolute position of the curtain.
Automatic function1-(4) Position of slats	0-100% [0%]	Set the absolute position of the slat

The four automatic functions of each channel can be configured with different parameter values. And you can choose which automatic block call (block A, block B).



Option for automatic only for hardware as from version 3.2	activ
Channel react on	Automatic position 1 - 4
Start up automatic position (value = 1)	ever
Action of blind at return of automatic position (value = 0)	not activ

With the setting of automatic option parameter, the execution condition of automatic function can be further controlled. For example, the automatic function must be executed when the channel is at an endpoint location.

More, you can also set whether to move when you receive a 0 signal. The precondition for the action of the zero signal is that the channel has not been moved in any other way.

#### Option parameters

Name	Range [Default]	Remark
Option for automatic	<ul style="list-style-type: none"> <li>● <b>Not active</b></li> <li>● active</li> </ul>	Activate the auto option parameter.
Channel react on	<ul style="list-style-type: none"> <li>● <b>Automatic position 1-4</b></li> <li>● Automatic position 1</li> <li>● Automatic position 2</li> <li>● Automatic position 3</li> <li>● Automatic position 4</li> </ul>	Select the channel to respond to which automatic functions.
Start up automatic position(value = 1)	<ul style="list-style-type: none"> <li>● <b>always</b></li> <li>● if position = UP</li> <li>● if position = DOWN</li> </ul>	When the automatic function object receives a signal, the automatic function execution condition is selected.
Action at reset of automatic position(value = 0)	<ul style="list-style-type: none"> <li>● <b>not active</b></li> <li>● move up</li> <li>● move down</li> </ul>	When the automatic function object receives the 0 signal, what operation the selection channel perform will do

### 3.7.2 Automatic blocks

In order to invoke the automatic function, the automatic function block must be activated. The two feature blocks "block A" and "block B" are available. When the functional block is activated, four automatic function objects appear.



### Automatic function object

NO.	Name	Length	Use
5	automatic position 1	1 bit	Automatic function block A, call object 1
6	automatic position 2	1 bit	Automatic function block A, call object 2
7	automatic position 3	1 bit	Automatic function block A, call object 3
8	automatic position 4	1 bit	Automatic function block A, call object 4
9	automatic position 1	1 bit	Automatic function block B, call object 1
10	automatic position 2	1 bit	Automatic function block B, call object 2
11	automatic position 3	1 bit	Automatic function block B, call object 3
12	automatic position 4	1 bit	Automatic function block B, call object 4

Automatic function object size is 1 bit, can assign group address arbitrarily. By calling the automatic function object, you can control the curtain to move to the set position.

Multiple channels can be controlled simultaneously (the channel of the simultaneous action is configured to the same block), a single channel action can be controlled as well.

## 3.8 Alert functions/superior functions

The curtain actuator can perform some protection according to the weather condition. To use weather warning, you must activate firstly.



**Channel A: Alarm and block functions**

---

Order of alarms	Wind, Rain, Frost, Block ▼
Action at reset of alarms / block	no action ▼
Action at blocking (value=1)	no action ▼
Extended block function	not activ ▼
Wind alarm	not activ ▼
Rain alarm	not activ ▼
Frost alarm	not activ ▼
Reaction when bus power down	no action ▼
Reaction when bus power up	no action ▼

### 3.8.1 Order of alarms

The parameter "order of alarms" sets the priority of various weather conditions.

Warning configuration

Name	Range [Default]	Remark
Order of alarms	<ul style="list-style-type: none"> <li>● Wind,Rain,Frost,Block</li> <li>● Wind,Rain,Block,Frost</li> <li>● Wind,Block,Rain,Frost</li> <li>● Block,Rain,Wind,Frost</li> </ul>	Set priorities for different weather conditions.

Multiple alerts may occur simultaneously, but the actuator only evaluates the highest priority alerts. Only after the highest priority warning is reset , the lower priority alert will be processed until all the warnings have been processed.

### 3.8.2 Alarm types

There are three different types of warning: wind, rain, frost.

Name	Range [Default]	Remark
<b>Wind alarm</b>	<ul style="list-style-type: none"> <li>● not active</li> <li>● active</li> </ul>	Activate the wind warning
Cycle time	0-120min [30min]	Periodically evaluate the warning signal, and the zero warning object will stop the periodic evaluation function.
Action	<ul style="list-style-type: none"> <li>● <b>no action</b></li> <li>● drive to top</li> <li>● drive to bottom</li> </ul>	The act of configuring an early warning.
<b>Rain alarm</b>	<ul style="list-style-type: none"> <li>● not active</li> <li>● active</li> </ul>	Activate warning of rain
Cycle time	0-120min [30min]	Periodically evaluate the warning signal, and the zero warning object will stop the periodic evaluation function.
Action	<ul style="list-style-type: none"> <li>● <b>no action</b></li> <li>● drive to top</li> <li>● drive to bottom</li> </ul>	The act of configuring an early warning.
<b>Frost alarm</b>	<ul style="list-style-type: none"> <li>● not active</li> <li>● active</li> </ul>	Activate frost warning
Cycle time	0-120min [30min]	Periodically evaluate the warning signal, and the zero warning object will stop the periodic evaluation function.
Action	<ul style="list-style-type: none"> <li>● <b>no action</b></li> <li>● drive to top</li> <li>● drive to bottom</li> </ul>	The act of configuring an early warning.

#### Warning object

NO.	Name	Length	Use
29	Wind alarm	1 bit	Wind warning. When setting 1, start the early warning evaluation, and stop the early warning evaluation at 0.
30	Rain alarm	1 bit	Rain warning. When setting 1, start the early warning evaluation, and stop the early warning evaluation at 0.
31	Frost alarm	1 bit	Frost warning. When setting 1, start the early warning evaluation, and stop the early warning evaluation at 0.

After activating the warning function, the corresponding warning object will appear in the configuration bar. When an object receives a 1, it indicates that the warning is generated and the warning is cancelled when 0 is received.

Three behaviors can be configured during early warning: no action, open and close. Four actions can be configured when the warning is lifted: no action, move to the previous position, open and close.

### 3.8.3 Periodic observation

The periodic evaluation function is activated when the parameter "Cycle Time" does not equal 0. The detection cycle can be set to a range of 0 to 120 minutes. When setting 0, the cycle assessment function is prohibited.

When the periodic evaluation function is activated, periodic warning signals must be received within the set time, otherwise the warning behavior will be implemented. In order to ensure that the early warning is not timed out, the warning signal sender must send the warning signal periodically within the set period.

Cycle Time (min, 0 = off) 30 [0..120]

### 3.8.4 Normal blocking

Name	Range [Default]	Remark
Action at blocking(Value = 1)	<ul style="list-style-type: none"> <li>● no action</li> <li>● drive to top</li> <li>● drive to bottom</li> </ul>	The blocking object of the activation channel.

Blocking behavior can be defined as: no action, open, close.

Once the blocking object is activated (receiving a 1 signal), the channel will no longer respond to other commands until the block is blocked.

NO.	Name	Length	Use
32	Block		Activate/disable blocking.

### 3.8.5 Action at reset of alarms and blocks

A behavior can be configured to perform when a channel warning or block is removed.

Name	Range [Default]	Remark
Action at reset of alarms/block	<ul style="list-style-type: none"> <li>● <b>no action</b></li> <li>● drive to former position</li> <li>● drive to top</li> <li>● drive to bottom</li> </ul>	The act of configuring an alert or blocking a reset.

Each channel can be set with four different reset behaviors:

"No action" means that no action is performed when warning or blocking the reset.

"Drive to former position" means to move to the previous position when warning or blocking the

reset. The last position refers to the last position before the alert or blocking activation.  
 "Drive to top" means to move to the top when warning or blocking the reset.  
 "Drive to bottom" means to move to the bottom when warning or blocking the reset.

### 3.8.6 Reaction when bus power down/up

The bus can also configure some behavior on/off.

Name	Range [Default]	Remark
Reaction when bus power down	<ul style="list-style-type: none"> <li>● no action</li> <li>● drive to top</li> <li>● drive to bottom</li> </ul>	
Reaction when bus power up	<ul style="list-style-type: none"> <li>● no action</li> <li>● drive to top</li> <li>● drive to bottom</li> </ul>	

The upper/lower electrical behavior of the actuator can be configured in three types: no action, open and close.

Note: the power drop does not work in a normal way because the device loses power, which is that the movement of the curtain is no longer under control.

## 3.9 Block functions

Each channel can extend the blocking function. After the extension function is activated, new parameters can be configured.

Extended block function 

- not activ
- not activ
- activ

---

**Channel A: Extended block function**

Object "Block absolute position"	<input type="text" value="activ"/>
Block of absolut position via object "Blinds Up/Down"	<input type="text" value="not activ"/>
Settings for object "Block universal mode"	<input type="text" value="activ"/>
The object blocking the following functions:	
Block manual control	<input type="text" value="not activ"/>
Block Up/Down movement	<input type="text" value="not activ"/>
Block absolute position mode	<input type="text" value="not activ"/>
Block automatic mode	<input type="text" value="not activ"/>
Block scene mode	<input type="text" value="not activ"/>

### Block parameters

Name	Range [Default]	Remark
Action at blocking(Value = 1)	<ul style="list-style-type: none"> <li>● <b>no active</b></li> <li>● drive to top</li> <li>● drive to bottom</li> </ul>	Configure blocking behavior
Block of absolute position via Objects "Blinds Up/Down"	<ul style="list-style-type: none"> <li>● <b>not active</b></li> <li>● active</li> </ul>	Activate blocking absolute position function
Settings for object "Block universal mode"	<ul style="list-style-type: none"> <li>● <b>not active</b></li> <li>● active</li> </ul>	Activate the general blocking function.
Block manual control	<ul style="list-style-type: none"> <li>● <b>not active</b></li> <li>● active</li> </ul>	Activate the blocking manual operation
Block up/down movement	<ul style="list-style-type: none"> <li>● <b>not active</b></li> <li>● active</li> </ul>	Activate blocking universal mobile operation.
Block absolute position mode	<ul style="list-style-type: none"> <li>● <b>not active</b></li> <li>● active</li> </ul>	Activate blocking absolute position operation.
Block automatic mode	<ul style="list-style-type: none"> <li>● <b>not active</b></li> <li>● active</li> </ul>	Activate the blocking auto operation.
Block scene mode	<ul style="list-style-type: none"> <li>● <b>not active</b></li> <li>● active</li> </ul>	Activate the blocking scenario operation.

### Blocking object

NO.	Name	Length	Use
27	Block absolute position	1 bit	Block absolute location objects
28	Block universal mode	1 bit	Generic blocking function blocks different objects depending on the parameter configuration

The absolute position command can be blocked by the parameter "block absolute position". When the corresponding object receives 1, the absolute position command received by the channel will be ignored and normal at 0.

## 4 Input general

The following figure is general interface global parameters:

Object "In operation" send	No
Debounce Time [ms]	30 ms
Time for keystroke long [s]	0,8 s
Inputs type	<input type="radio"/> DisablePullup <input checked="" type="radio"/> EnablePullup
Behaviour at Bus power up(Input)	<input checked="" type="radio"/> No read value for toggle <input type="radio"/> Read value for toggle

### General Settings

Parameter Name	Range [Default]	Remark
Send "In operation" object	<ul style="list-style-type: none"> <li>● No</li> <li>● Send value "0" cyclic</li> <li>● Send value "1" cyclic</li> </ul>	The "In operation" object is sent to the bus reporting device to run normally, and the periodic send value can be selected "0" or "1".
Send cycle time in s[1...65535]	1-65535s [60]	Send the "In operation" object cycle time setting.
Debounce time	10-120ms [30]	Signal input buffering time, optional 10ms,30ms,60ms and 120ms.
Time for keystroke long	0.1-30s [0.8s]	Long key determination time (longer than this value is longer button), it is necessary to determine the value when the length of the key is differentiated.
Input Type	<ul style="list-style-type: none"> <li>● Disable Pullup</li> <li>● Enable Pullup</li> </ul>	Select "no pull" or "pull up" inside the input channel.
Behavior at bus power up	<ul style="list-style-type: none"> <li>● No read value for toggle</li> <li>● Read value for toggle</li> </ul>	When the device is reset, read the rollover value and default to 0.

### Input parameters:

#### Input Type(only used to Input pins)

The switch executor extended input can be configured to internally pull or disable internal pull-up function, with the purpose of enabling internal pull-up function to be compatible with passive signal input and active signal input.

- Disable Pullup

The internal pull-up function is forbidden. The input signal is high level and effective, and the input of dry contact points is 3.3v ~24VDC.

- Enable Pullup

Enable internal pull function, input signal is low level effective, dry contact input, low level input is lower than 1VDC positive level signal, and compatible with OC door input.



## 4.1 Input channel configuration

Below is the channel mode selection:

Function Input Type A / B	<input checked="" type="radio"/> Channels unique	<input type="radio"/> Channels grouped
Function Input A	<input checked="" type="radio"/> disabled	<input type="radio"/> enabled
Function Input B	<input checked="" type="radio"/> disabled	<input type="radio"/> enabled
Function Input Type C / D	<input checked="" type="radio"/> Channels unique	<input type="radio"/> Channels grouped
Function Input C	<input checked="" type="radio"/> disabled	<input type="radio"/> enabled
Function Input D	<input checked="" type="radio"/> disabled	<input type="radio"/> enabled

Function description:

Parameter Name	Range [Default]	Remark
Function Input Type A / B 、 C / D	<ul style="list-style-type: none"> <li>● Channels unique</li> <li>● Channels grouped</li> </ul>	Channel working mode: Channels unique means that Channels work in independent mode; Channels are represented as channel work in combination mode;
Function Input A, B, C, D; Function Input A / B, C / D	<ul style="list-style-type: none"> <li>● disabled</li> <li>● enabled</li> </ul>	Disabled means that the channel does not work; Enabled means that the channel works;

### 4.1.1 The input channel is configured with the same parameters

#### 4.1.1.1 Blocking Object

Each channel can activate the blocking function, and each channel function has its own blocking object.

The following is the object description:

NO.	Name	Length	Use
38	Blocking object	1bit	When the value 1 is received, the blocking channel (the channel will no longer generate any action), the value 0 returns to normal.

## 4.2 Composite pattern parameter configuration

The following table shows the group mode parameter options:

Parameter Name	Range [Default]	Remark
Input A/B	<ul style="list-style-type: none"> <li>● <b>Dimming</b></li> <li>● Shutter</li> <li>● Switch</li> </ul>	Work mode selection: dimming, shutter, switch.
Dimming function A/B	<ul style="list-style-type: none"> <li>● <b>Brighter/Darker</b></li> <li>● Darker/Brighter</li> </ul>	Set the dimming mode, the former is A and the latter is B.
Shutter function A/B	<ul style="list-style-type: none"> <li>● <b>Up/Down</b></li> <li>● Down/Up</li> </ul>	Set the shutter mode, the former is A and the latter is B.
Switch function A/B	<ul style="list-style-type: none"> <li>● <b>On/Off</b></li> <li>● Off/On</li> </ul>	Set the switch mode, the former is A and the latter is B.
Blocking Object	<ul style="list-style-type: none"> <li>● <b>Inactive</b></li> <li>● Active</li> </ul>	Set blocking function by default.

When selecting a combination mode, the adjacent two channels will be configured to combine functions.

### 4.2.1 Dimming control

Two key dimming function work in combination mode.

The following figure is the parameter option:

The screenshot shows a configuration window titled "Input A / B". It contains three rows of settings, each with a label on the left and a dropdown menu on the right:

- Input A / B: Dimming
- Dimming Function A / B: Brighter/Darker
- Blocking Object: Inactive

#### Parameter Description

Length	Name	Length	Use
34	Dimming on/off	1 bit	Switch function, short button is valid.
35	Dimming	4 bit	Switch function, long button is valid.

When a group of channel configured to the dimming function, there will be two objects, a corresponding short key, one object used to control and off, a long for object corresponding to the key, is used to control the dimming.

Brighter/part or part/Brighter optional configuration, the former corresponds to the first input, the

latter corresponding to the second input. For example: A channel to be Brighter/part A/B, the channel A is the bright, channel B is dim. Short key channel A direct lights, channel B, shut the lights directly. Long keys, channel A move bright light according to the set time is slow, slow channel B dim the lights. Long keys that move light, midway at any time to loosen keystrokes, stop that move light, light to keep the current brightness, dimming again will continue to start from the current brightness adjustable light. When the brightness to the maximum or minimum brightness will not change anymore.

The image below is a two-channel dimming.

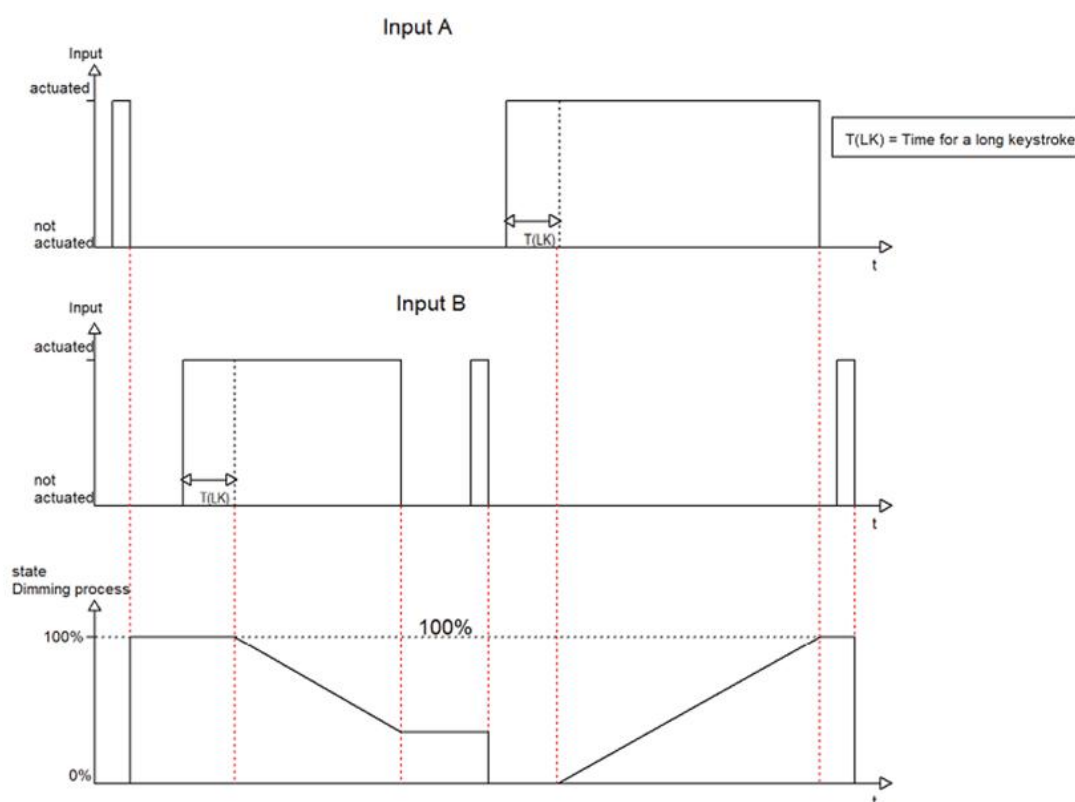

## 4.2.2 Shutter Control

Two - key curtain control, can control curtain, shutter.

Input A / B	Shutter
Shutter Function A / B	Up, Down
Operation function	Long=move / short=stop/slats
Blocking Object	Inactive

NO.	Name	Length	Use
34	Shutter Down/Up	1 bit	Drive the curtain up and down, long button effective
35	Stop/Blinds Open/Close	1 bit	Stop moving, the short button is valid.

When curtain of channel A/B is configured to control, and parameter selection Up/Down, the long press A button, the device will send A signal, the curtain will move Up, long press B button, the device will send A 1 signal, the curtain will move Down. Short press A or B will be sent to stop signals. If the parameter selection Down/Up, the function of A/B swap. If the operation mode selection for short = move/long = stop/slats, the short keys that dimming, long button to stop.

### 4.2.3 Switch Control

When two channels are configured to switch mode, switch control can work.

**Input A / B**

Input A / B	Switch ▼
Switch function A / B	on / off ▼
Blocking Object	Inactive ▼

Switch object description:

NO.	Name	Length	Use
34	Switch On/Off	1 bit	Switch object

When the channel A/B is configured as A combination switch mode, and the parameter On/Off is selected, press A to send 1 signal, and press B to send 0 signal.

## 4.3 Independent pattern parameter configuration

There are 7 options for channel work:

- Switch
- Switch short/long
- One button dimming
- One button shutter
- Counter
- Scene
- LED output

Where Inactive is the channel bar, and the corresponding parameters of the channel are no longer displayed.

---

### 4.3.1 Switch

The switch function can respond to different keystrokes (press, release), and delay sending. There will be more when you are selected for a sub-option. For other parameter options, see the following section.

The following figure is the switch function option.

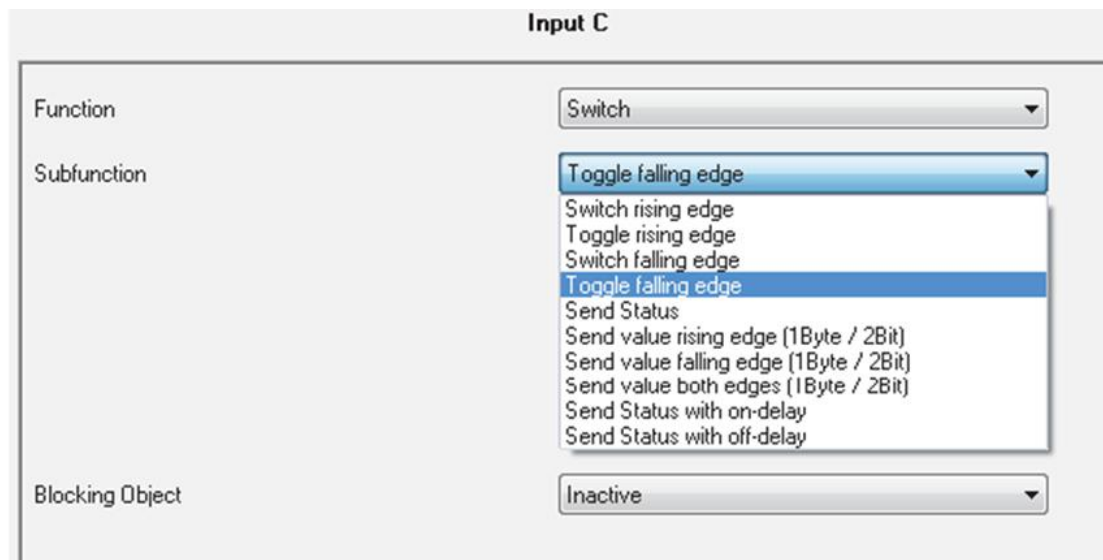

#### 4.3.1.1 Switch falling edge/rising edge/both edge

Edge configuration parameter figure:

Parameter name	Range [Default]	Remark
Value for rising/falling edge	<ul style="list-style-type: none"><li>● On</li><li>● Off</li></ul>	

Open/close can be pressed/released at will.

When the channel chooses the edge Switch rising edge or the Switch falling edge, a On or Off signal will be sent under the corresponding action.

The following figure shows the channel configuration as the Switch rising edge, and the effect of sending On signal:

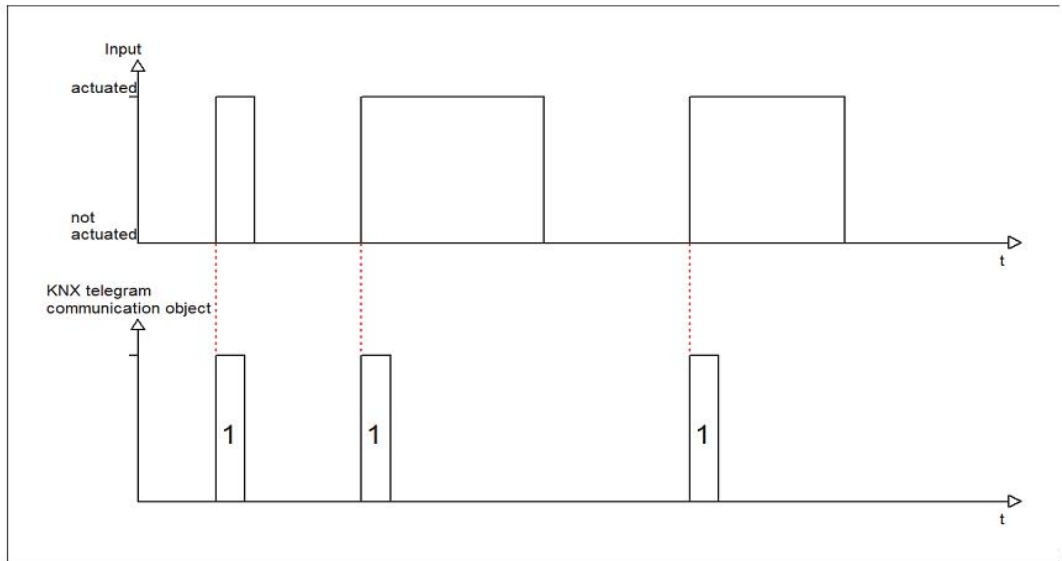

The following table is the corresponding communication object:

NO.	Name	Length	Use
34	Switch		

Press the button to send corresponding signal, long press/short press no influence.

### 4.3.1.2 Toggle rising/falling edge

Rising channel can be configured to delay (press), or fall (release) toggle output. Each toggle based on State feedback last time, that means will flip the object (Value for toggle) (State) associated with the target State object to work properly.

The following figure shows the channel configured as a drop delay (release), and the toggle function.

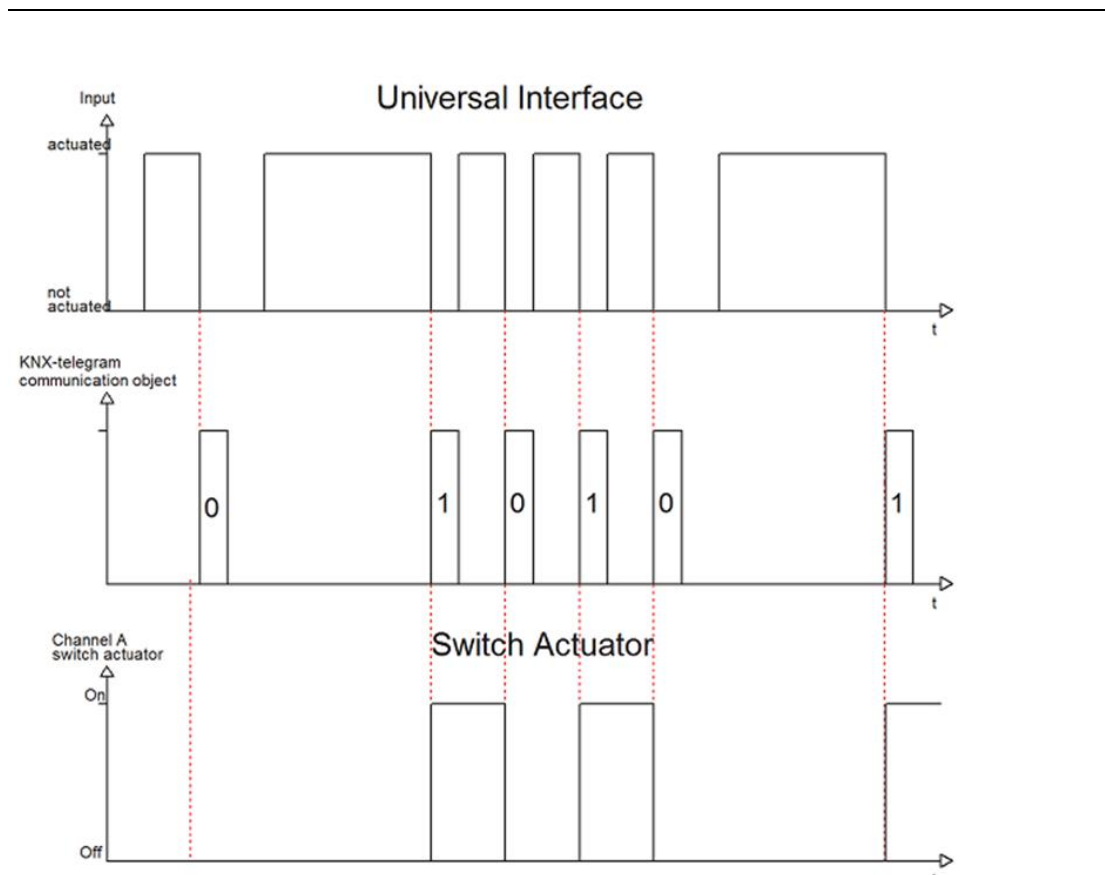

The following table is the corresponding communication object:

NO.		Length	Use
34	Switch	1 bit	Press the button to send corresponding signal, long press/short press no influence.
35	Value for toggle	1 bit	The connection status object, which reflects the current state of the target, is used to toggle the function.

Object Value for toggle is related to toggle the normal implementation of function, therefore, must connect it to the target channel on the state of the object, if there is no target object, you should connect the Switch to the channel object. Also can be configured on the device when read updates the object values, which is same to that of the target state.

### 4.3.1.3 Send Status

When the channel is configured with a Switch and the Send Status function, the channel can Send a set value when it is up or down.

Configuration Table:

Function	Switch
Subfunction	Send Status
Value for rising edge	On
Value for falling edge	Off
Blocking Object	Inactive
Behaviour at Bus power up	send nothing
Send cyclic activ	Off

#### Parameter Description:

Parameter Name	Range [Default]	Remark
Value for rising edge	<ul style="list-style-type: none"> <li>● On</li> <li>● Off</li> </ul>	Send the signal when pressed
Value for falling edge	<ul style="list-style-type: none"> <li>● On</li> <li>● Off</li> </ul>	To send a signal when released.
Send cycle	<ul style="list-style-type: none"> <li>● Off</li> <li>● On</li> </ul>	Periodically send signals.
Time interval for send cyclic	1-3000s [1]	Interval time
Behavior at bus power up	<ul style="list-style-type: none"> <li>● <b>Send nothing</b></li> <li>● Send status</li> </ul>	Whether the bus is sent when it is on power.

#### Object Description

NO	Name	Length	Use
34	Switch	1 bit	Send switch value, no difference between short and long key.

Send state function can be used to perform some special functions, testing closed state, for example, the opening and closing of the window, when touch point with a window, so the Send status function can be used to make the window state to monitor. Can also be sent to the current input state.

The following figure shows the send 0 signal, and the sending 1 signal is released:



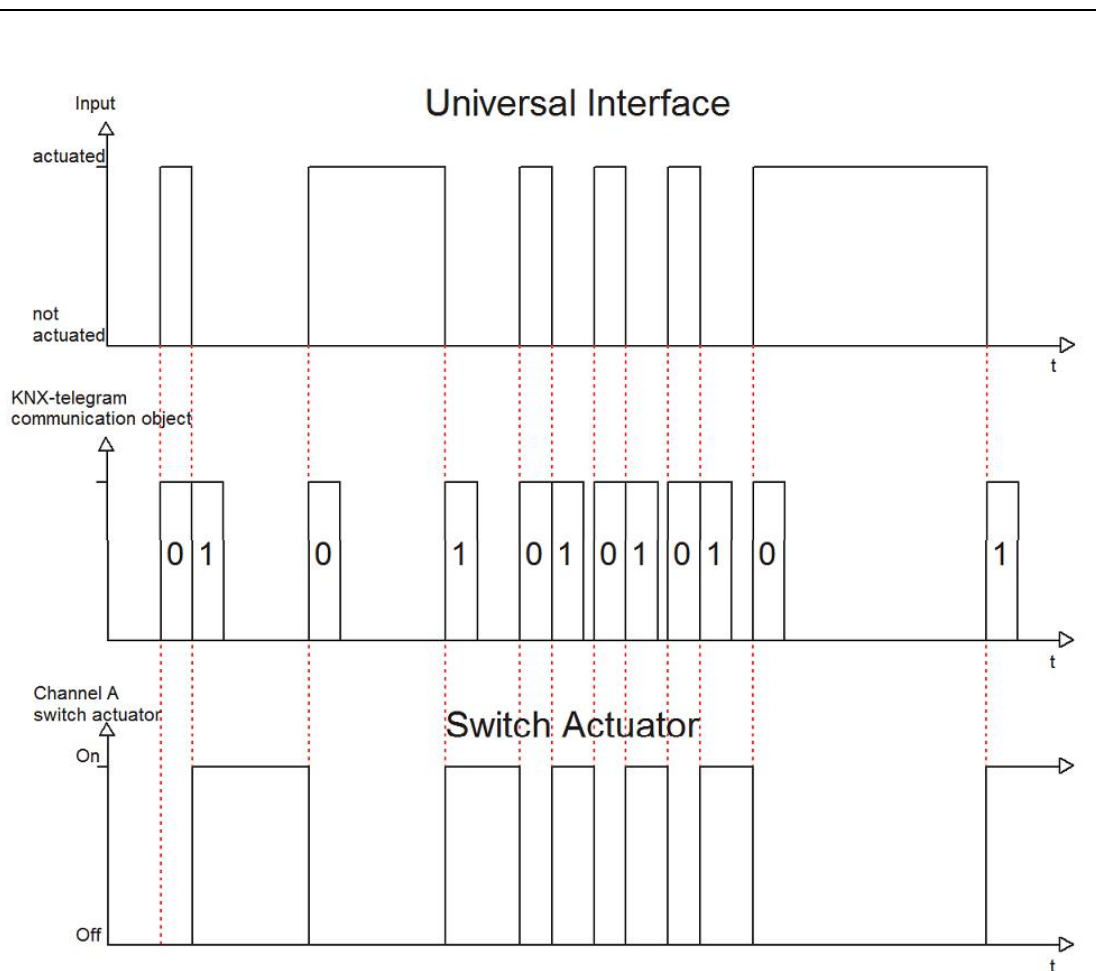

#### 4.3.1.4 Send Value rising/falling/both edges

There are two values that can be sent, one byte, one two bit, depending on your choice.

Parameter

Function	Switch
Subfunction	Send value both edges (1Byte / 2Bit)
Value (1Byte) / forced setting (2Bit)	1 Byte value
Value for rising edge	0
Value for falling edge	0
Behaviour at Bus power up	send nothing
Blocking Object	Inactive

The following table is 1 byte value parameter:

Parameter Name	Range [Default]	Remark
Value for rising/falling edge	0-255 [0]	Sends a 1 byte value on the set edge (up, down)

For a 1 byte object, it can send any value within a range of 0-255 depending on your Settings.

The following is the object description:

NO.	Name	Length	Use
34	Send value		Send a set value.

The following table is two value parameters:

Parameter Name	Range [Default]	Remark
Send forced setting at rising/falling	Forced setting not active Forced setting off Forced setting on	Send a 2 bit value on the set edge (up, down).

The two objects can be used to do some, for example, human body induction automation control.

The parameters are as follows:

● Forced setting not active (control = 0, value = 0)

Body sensors work normally.

● Forced setting off (control = 1, value = 0)

The body's sensors are forced to shut down and no longer sense the external environment.

● Forced setting on (control = 1, value = 1)

Body sensors are forced to open.

The following table is two value object:

NO.	Name	Length	Use
34	Send forced setting	2 bit	Send a set value

#### 4.3.1.5 Send value with on/off delay

The following table shows the delay sending parameters:

Parameter Name	Range [Default]	Remark
Delay time	0-60min [1s]	Send value after delay setting time.

To send child function value with on/off delay, is send on or off value, delay some time before we send. If prior to the completion time delay, the channel back to the previous state, the time delay end ahead of time, and do not send values. For example, channel press, send delay 3 seconds on value, and before the time arrived, channel was released, the channel delay end, no longer send on value.

The following figure shows the operation:

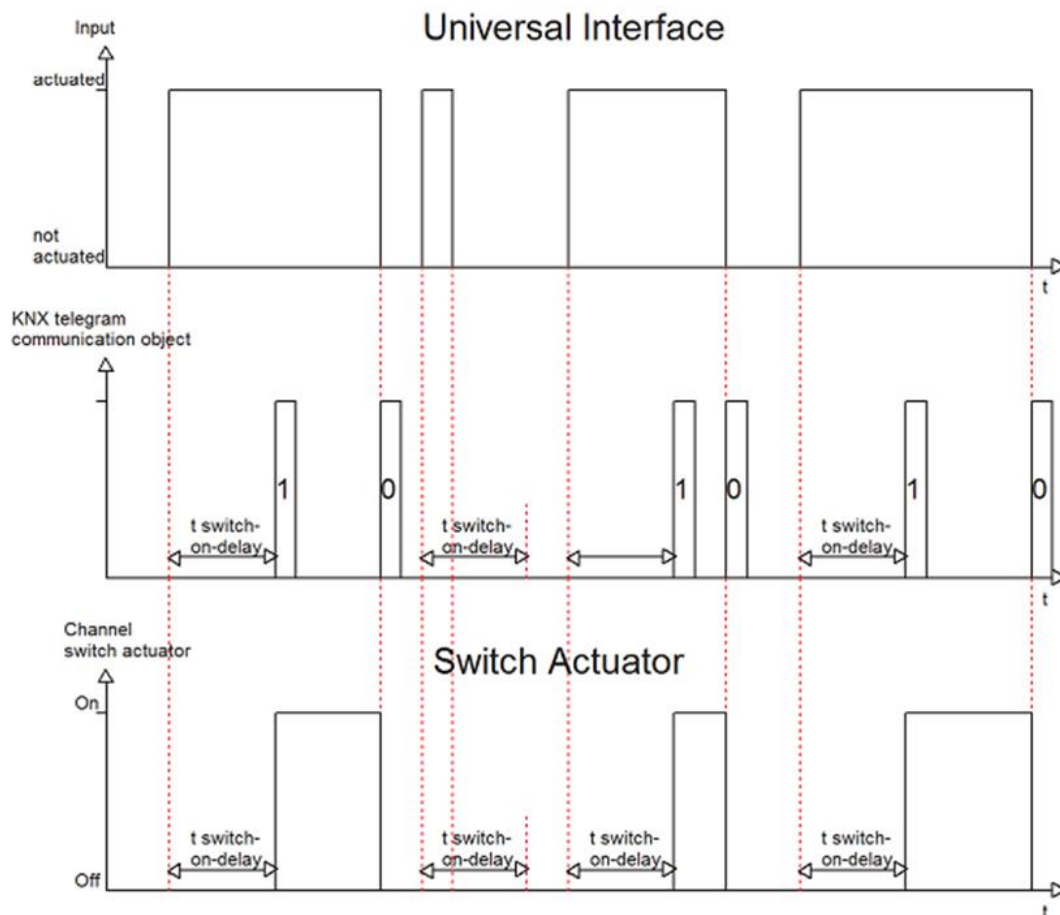

Parameter:

Function	Switch
Subfunction	Send Status with off-delay
Delay time	1 s
Blocking Object	Active

Object Description;

NO.	Name	Length	Use
34	Switch	1 bit	Press the delay to send the On value, and release the delay to send Off the value

### 4.3.2 Scene

Scene function can be used to control one or more actuators of multiple channels, to realize the state of a scene. In addition, in the case of active learning function, it can be sent through long key learning command.

Parameter Configuration:

Function	Scene
Subfunction	Save
Scene Number	1
Blocking Object	Inactive

Parameter Description:

Parameter Name	Range [Default]	Remark
Saving function	<ul style="list-style-type: none"> <li>● No save</li> <li>● <b>Save</b></li> </ul>	When the save function is activated, the long key can learn and save the current channel value.
Scene number	1-64 [1]	The scenario number must be configured to be the same as the executor.
Blocking object	<ul style="list-style-type: none"> <li>● <b>Inactive</b></li> <li>● Active</li> </ul>	Blocking object, by default

Object Description

NO.	Name	Length	Use
36	Scene	1 byte	Send scene value

Short key is sent to set the scene, the same group address actuators scene object will receive scene, and perform the corresponding action. When the activation of the function of learning, learn by long keys will be sent a command to the associated actuators, actuators will save the current

---

channel status to the corresponding scenario.

The following table sends and saves the corresponding values for the scene:

Scene	Send		Save	
	Hex.	Dez.	Hex.	Dez.
1	0x00	0	0x80	128
2	0x01	1	0x81	129
3	0x02	2	0x82	130
4	0x03	3	0x83	131
5	0x04	4	0x84	132
6	0x05	5	0x85	133
7	0x06	6	0x86	134
8	0x07	7	0x87	135
9	0x08	8	0x88	136
10	0x09	9	0x89	137
11	0x0A	10	0x8A	138
12	0x0B	11	0x8B	139
13	0x0C	12	0x8C	140
14	0x0D	13	0x8D	141
15	0x0E	14	0x8E	142
16	0x0F	15	0x8F	143
17	0x10	16	0x90	144
18	0x11	17	0x91	145
19	0x12	18	0x92	146
20	0x13	19	0x93	147
21	0x14	20	0x94	148
22	0x15	21	0x95	149
23	0x16	22	0x96	150
24	0x17	23	0x97	151
25	0x18	24	0x98	152
26	0x19	25	0x99	153
27	0x1A	26	0x9A	154
28	0x1B	27	0x9B	155
29	0x1C	28	0x9C	156
30	0x1D	29	0x9D	157
31	0x1E	30	0x9E	158
32	0x1F	31	0x9F	159

### 4.3.3 Counter

The counter function can be used to count the number of switches. It can be configured as a rise delay count, a drop delay count, or a lower down count.

Function	Counter
Subfunction	Count rising and falling
Sending difference	5
Blocking Object	Inactive

Parameter Description:

Parameter Name	Range [Default]	Remark
Sub-function	<ul style="list-style-type: none"> <li>● Count rising</li> <li>● Count falling</li> <li>● <b>Count rising and falling</b></li> </ul>	Setting the edge count, up/down edge is counted down by default
Sending difference	0-65535 [5]	The current value is sent for each increment of the set value.
Blocking object	<ul style="list-style-type: none"> <li>● <b>Inactive</b></li> <li>● Active</li> </ul>	Blocking object, by default

Object Description

NO.	Name	Length	Use
34	Reset Counter	1 bit	Reset counter
37	Counter	4 byte	Output counter value

Counter at the edge of the set of counting. For example, set to increase/decrease count, sending interval is 5, increased delay counting time, drop in counting time, count to five will be sent when the current count value, when the count reaches 10 send count again, and so on.

The communication object reset counter is used to reset the counter value to 0, and the object value 0,1 is valid.

The following figure shows the increase/decrease delay count, and sending interval 5:

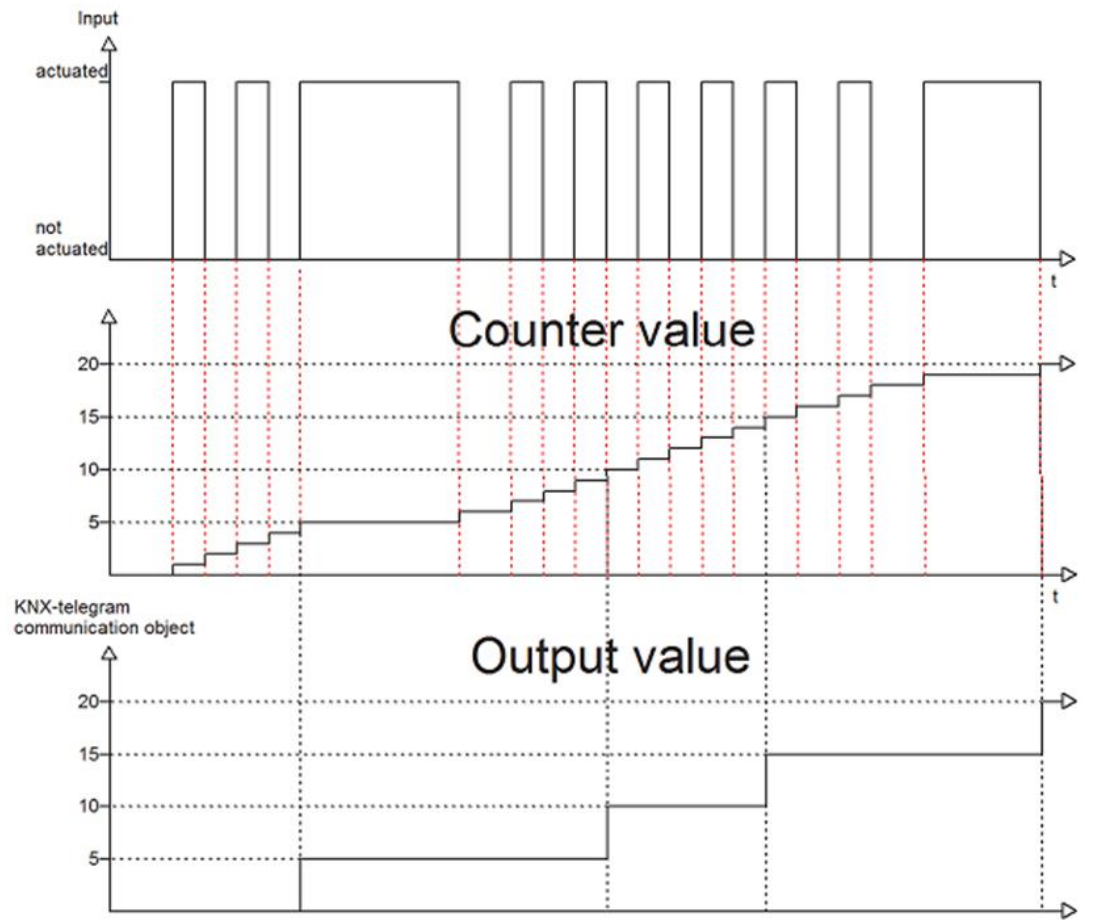

### 4.3.4 Switch short/long

Long press/short can be independently assigned to open/close/toggle/send values and other functions.

Function	Switch short/long
Value for keystroke short - Object 1	On
Value for keystroke long - Object 2	Toggle
Blocking Object	Inactive

### Parameter Description

Parameter Name	Range [Default]	Remark
Value for keystroke short object 1	<ul style="list-style-type: none"> <li>● <b>On</b></li> <li>● Off</li> <li>● Toggle</li> <li>● Send value</li> <li>● Nothing</li> </ul>	For short press
Value for keystroke long object 2	<ul style="list-style-type: none"> <li>● On</li> <li>● Off</li> <li>● Toggle</li> <li>● Send value</li> <li>● <b>Nothing</b></li> </ul>	For long press
Blocking object	<ul style="list-style-type: none"> <li>● <b>Inactive</b></li> <li>● Active</li> </ul>	

### Object Description

NO.	Name	Length	Use
34	Push-button short	1 位	Object for short keys.
35	Value for toggle short	1 位	Short button toggle value
36	Push-button long	1 位	Object for long keys.
37	Value for toggle long	1 位	Long button toggle value

Single key short/long press key function can be used to control two channels, this can save a button. Or it can be short press, long press, and can be short press, long press turn.

When configured to toggle, the corresponding toggle object must be connected to the state object of the controlled actuator channel to achieve the correct toggle

The following figure shows the command description. The long press/short press is set as the rollover function, and the long press control actuator channel A, short press control channel B:



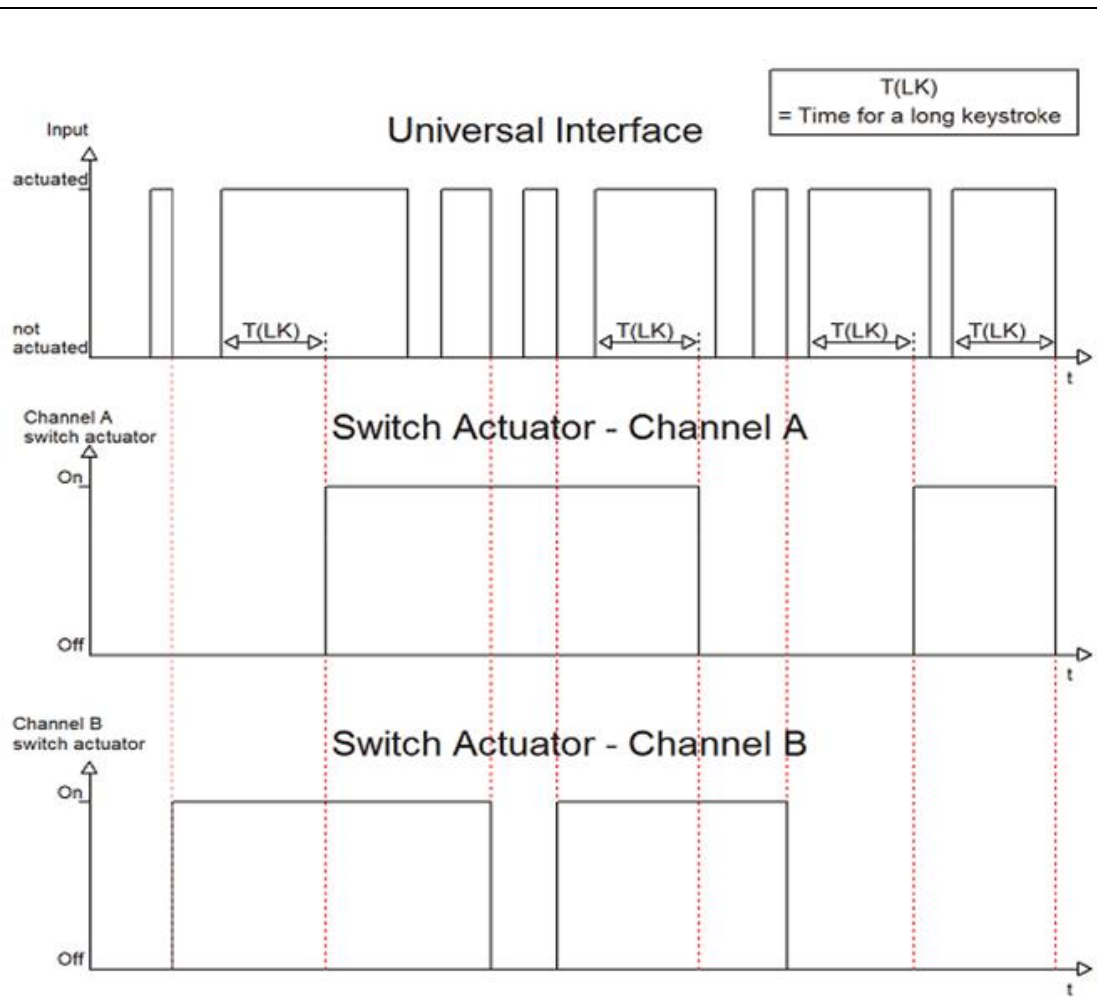

The following table shows the parameter description for selecting function Send value:

Parameter Name	Range [Default]	Remark
Value for keystroke short/long	Send value	The sub-function is selected as the send value.
Send value	<ul style="list-style-type: none"> <li>● 1 Byte-Value[0...255]</li> <li>● Scene number</li> </ul>	Value selection: one byte unsigned value, one is the scenario value.
1 Byte-Value[0...255]	0-255 [0]	A byte unsigned value, ranging from 0 to 255. Can be used for absolute dimming control.
Scene number	1-64 [1]	A byte scenario value, ranging from 1 to 64. Can be used for scenario control.

### 4.3.5 One button Dimming

Single key can realize dimming, opening/closing.



Parameter Description:

Parameter Name	Range [Default]	Remark
Blocking object	<ul style="list-style-type: none"> <li>● Inactive</li> <li>● Active</li> </ul>	Blocking function

Object Description:

NO.	Name	Length	Remark
34	Dimming on/off	1 bit	Same with the switch function, the short button is effective, each time it is toggled
35	Dimming	4 bit	Relative dimming, long button effective.
36	Value for toggle	1 bit	Receives the channel status value

Single bond dimmer can achieve on/off, dimming function. Short key and switch function is the same, every button to flip. Long keys to realize relatively light, reaches the maximum/minimum brightness change, no longer release button to stop the dimming. Because it is a single bond dimmer, so every time long keys that move light change direction. Assuming that the current dimmer upwards, the direction of the next move light downward. The lithography degree 100% every time.

The following figure shows the adjustment of light:

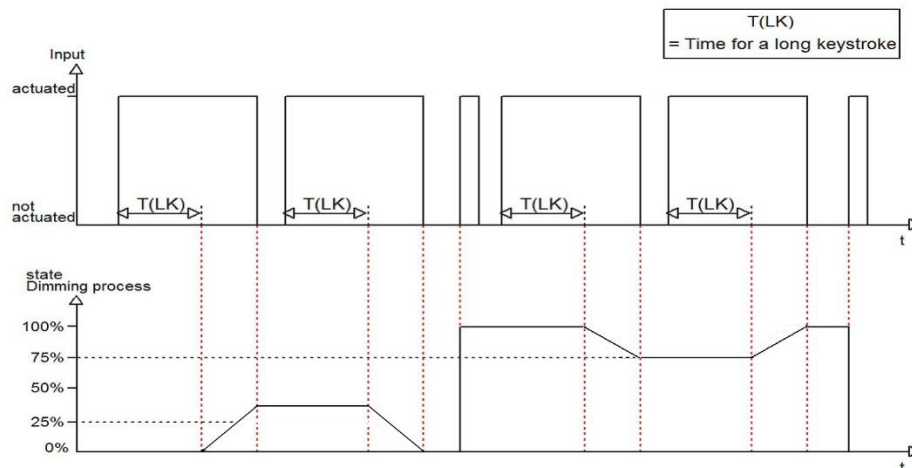

### 4.3.6 One button Shutter

Function	One Button Shutter
Operation function	Long=move / short=stop/slats
Blocking Object	Inactive

Parameter Description:

Parameter Name	Range [Default]	Remark
Blocking object	<ul style="list-style-type: none"> <li>● Inactive</li> <li>● Active</li> </ul>	Blocking function

Object Description

NO.	Name	Length	Use
34	Shutter	1 bit	The curtain moves, the long button is valid
35	Blinds/Stop	1 bit	The curtain stops, the short button is valid
36	Value for change of direction	1 bit	Indicate current direction

The long button controls the curtain movement, changing direction each time, and assuming that the current is moving upward, the next time it moves down. When the short button is sent, the Stop command is sent by the object Blinds/Stop.

### 4.4 LED output

Function	LED output
LED state at objectvalue 0/1	OFF/ON (normaly)
LED state at ON	Permanent
Behavior of LED at undefined object	OFF

### Parameter Description

Parameter Name	Range [Default]	Remark
LED state at object value 0/1	<ul style="list-style-type: none"> <li>● <b>OFF/ON(normal)</b></li> <li>● ON/OFF(inverted)</li> </ul>	Indicates the way the LED responds to the value of the object.
LED state at ON	<ul style="list-style-type: none"> <li>● <b>Permanent</b></li> <li>● blinking</li> </ul>	Indicating light mode, always bright/flashing.
Behavior of LED at undefined object	<ul style="list-style-type: none"> <li>● <b>OFF</b></li> <li>● Short flash</li> </ul>	When the LED object has no valid value, the LED state is defined.

### LED Object

NO.	Name	Length	Use
76	LED Output A	1 bit	Control LED output.

The LED output function can directly drive the external LED without additional electronic components. The output voltage is 3.3v, and the integration has 1k current limiting resistance. It is forbidden for large current LED drivers.

The LED can normally respond to the object value (1= open,0= close), or reverse display (0= open,1= close). Also, the LED lighting mode can be configured, which is always bright/flashing.

## 4.5 Logic

The device extension input contains two logical control blocks. Various input/output methods can be configured.

Behaviour at Bus power up 
 no read ext. logic objekts  
 read ext. logic objects

Settings for logic 1 And ▼

Objecttype 1 Switch ▼

Sending condition not automatic ▼

Output inverted 
 No  Yes

Settings for logic 2 Or ▼

Objecttype 2 Switch ▼

Sending condition not automatic ▼

Output inverted 
 No  Yes

Parameter Name	Range [Default]	Remark
Behavior at bus power up	<ul style="list-style-type: none"> <li>● No read ext.logic objects</li> <li>● Read ext.logic objects</li> </ul>	Specifies whether the logical object value is read when the device is on power. When configured to read, the device reads and updates the value of the external logical object, otherwise the default value is 0.

Function Option:

Setting per logic [default value]	Dynamic range [default value]	Remark
<ul style="list-style-type: none"> <li>● Disabled</li> <li>● And</li> <li>● Or</li> </ul>	<ul style="list-style-type: none"> <li>● Switch</li> <li>● Scene</li> <li>● 1 byte value</li> </ul>	The logical object can be configured as And/Or operation, And the optional function has three kinds : switch/scene/1 byte value.

Object Description:

NO.	Name	Length	Use
64	Logic input 1A	1 bit	The external logical input object is valid when activated.
65	Logic input 1B	1 bit	The external logical input object is valid when activated.
66	Logic output 1	1 bit	Logic output object, activate switch function effectively.
66	Logic output 1 Scene	1 byte	The logical output object, which activates the scene or 1 byte value, is valid.

A total of two sets of logical objects, the other group of objects from 113 to 115, functions are same.

When a logical block is activated, there will be a new parameter configuration dialog. More parameters can be selected. Two external logic object can choose whether to activate or not, activation of corresponding objects can be configured after group address. In addition, all channel equipment can choose whether to join the logical operation or not.

The following figure shows the input options, including two external logical objects, four channels:

Logical object 1 A (external)	disabled ▼
Logical object 1 B (external)	disabled ▼
Input A	disabled ▼
Input B	disabled ▼
Input C	disabled ▼
Input D	disabled ▼

### 4.5.1 Logic object type switch

Parameter Name	Range [Default]	Remark
Send condition	<ul style="list-style-type: none"> <li>● Not automatic</li> <li>● Change of input</li> <li>● Change of output</li> </ul>	Set output condition.
Output inverted	<ul style="list-style-type: none"> <li>● No</li> <li>● Yes</li> </ul>	Set the output in reverse.

For sending condition change of input, when any activation state of input output state is changed. For any change of the output, send conditions only when all the input signal is set logical operation, after the state and is not the same as before, only the output state.

As for the reverse output function, it refers to the output 1 when the logical operation result is 0, and the output 0 is 1.

The following figure shows the signal description, the logic function is configured as Switch, And operation, the activation channel A/B, and an external logical object, the output reverse:

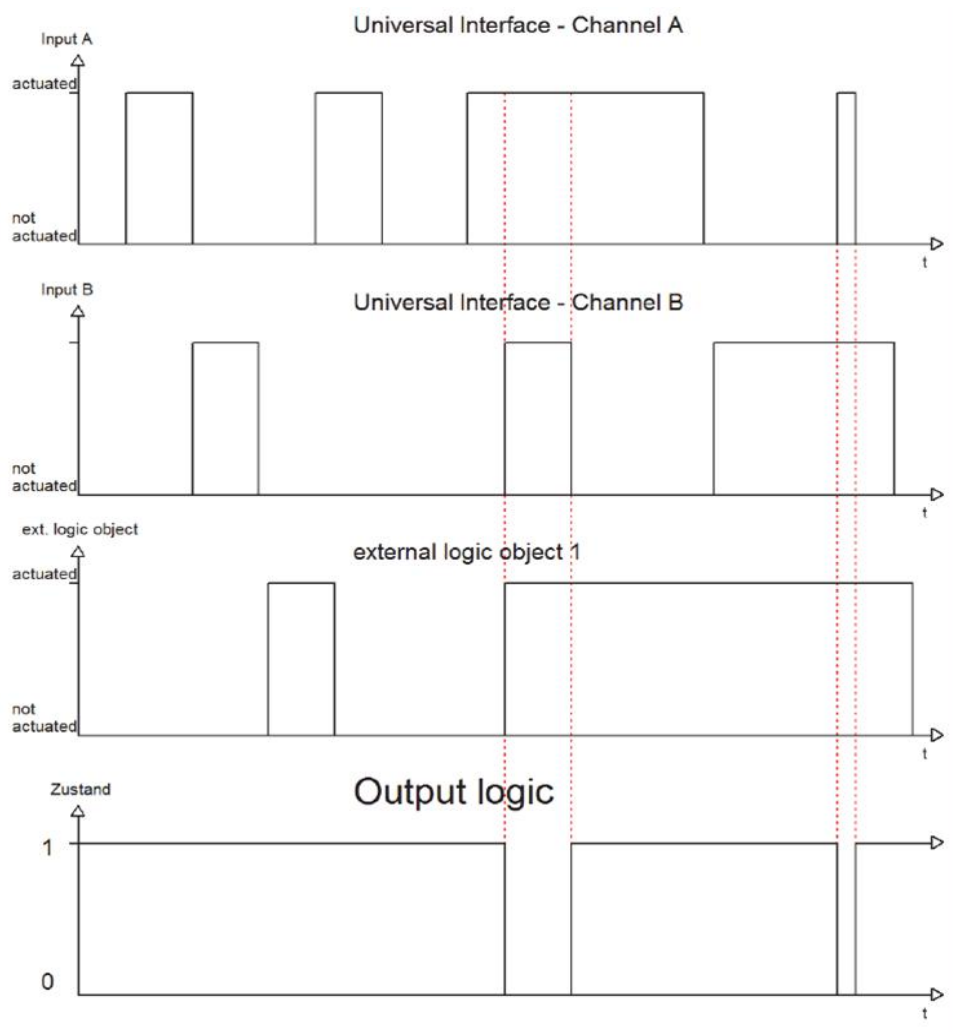

---

In the figure above, only when three inputs are 1, And operation result of the is 1, the output of the reverse is 0, And the other time output is 1.

### 4.5.2 Logic object type scene

After the logical block is configured as a scenario function, the output set scenario value is set when the logical operation result is 1, and only when the logical operation result is changed from 0 to 1, you output a scenario value.

Parameter Name	Range [Default]	Remark
Scene number	1-64 [2]	Set scene No..

### 4.5.3 Logic object type byte value

Parameter Name	Range [Default]	Remark
Byte value[0...255]	0-255 [0]	The byte value sent

As same as the scenario function, output a set byte value as long as the result of the logical operation is 1.